

OWNER'S OPERATING MANUAL

CinemaWall™

SP-42

Flat Panel Plasma Display Monitor
with
Widevision™



THE WORLD'S FINEST HOME THEATER PRODUCTS™

... will not cause damage to your display under normal conditions. Many DVD players are also equipped with screen savers for this reason.

TO AVOID IMAGE RETENTION (Burn-in): Please ensure that still images are left on your plasma display panel for no more than a few minutes. Also ensure that images displayed in the 4:3 aspect ratio mode (black or gray stripes, but no picture information is present on the left and right edges of the screen) are used as infrequently as possible. This will prevent permanent image burns on your plasma display panel, which can be seen permanently under certain conditions once burn-in has occurred.

The types of images to avoid include video games, still images and computer screens with stationary tool bars and icons. (This is why computers are equipped with screen savers – to prevent still images from burning into the monitor's phosphors after being displayed continuously for an extended period of time).

This Limited Warranty only covers failure due to defects in materials and workmanship that occur during normal use and does not cover normal maintenance. This Limited Warranty does not cover cabinets or any appearance items; failure resulting from accident, misuse, abuse, neglect, mishandling, misapplication, faulty or improper installation or setup adjustments; improper maintenance, alteration, improper use of any input signal; damage due to lightning or power line surges, spikes and brownouts; damage that occurs during shipping or transit; or damage that is attributed to acts of God. In the case of remote control units, damage resulting from leaking, old, damaged or improper batteries is also excluded from coverage under this Limited Warranty.

CAUTION: THIS LIMITED WARRANTY ONLY COVERS RUNCO PRODUCTS PURCHASED FROM RUNCO AUTHORIZED DEALERS. ALL OTHER PRODUCTS ARE SPECIFICALLY EXCLUDED FROM COVERAGE UNDER THIS WARRANTY.

MOREOVER, DAMAGE RESULTING DIRECTLY OR INDIRECTLY FROM IMPROPER INSTALLATION OR SETUP IS SPECIFICALLY EXCLUDED FROM COVERAGE UNDER THIS LIMITED WARRANTY. IT IS IMPERATIVE THAT INSTALLATION AND SETUP WORK BE PERFORMED ONLY BY AN AUTHORIZED RUNCO DEALER TO PROTECT YOUR RIGHTS UNDER THIS WARRANTY. THIS WILL ALSO ENSURE THAT YOU ENJOY THE FINE PERFORMANCE OF WHICH YOUR RUNCO PRODUCT IS CAPABLE WHEN INSTALLED AND CALIBRATED BY RUNCO AUTHORIZED PERSONNEL.

RIGHTS, LIMITS AND EXCLUSIONS:

Runco limits its obligations under any implied warranties under state laws to a period not to exceed the warranty period. There are no express warranties. Runco also excludes any obligation on its part for incidental or consequential damages related to the failure of this product to function properly. Some states do not allow limitations on how long an implied warranty lasts, and some states do not allow the exclusion or limitation of incidental or consequential damages. So the above limitations or exclusions may not apply to you. This warranty gives you specific legal rights, and you may also have other rights that vary from state to state.

EFFECTIVE WARRANTY DATE:

This warranty begins on the effective date of delivery to the end user. For your convenience, keep the original bill of sale as evidence of the purchase date.

IMPORTANT -- WARRANTY REGISTRATION:

Please fill out and mail your warranty registration card. It is imperative that Runco knows how to reach you promptly if we should discover a safety problem or product update for which you must be notified.

CONTACT A RUNCO AUTHORIZED SERVICE CENTER TO OBTAIN SERVICE:

Repairs made under the terms of this Limited Warranty covering your Runco video product will be performed at the location of the product, during usual working hours, providing location of product is within normal operating distance from a Runco Authorized Service Center. In some instances it may be necessary for the product to be returned to the Runco factory for repairs. If, solely in Runco's judgment, location of product to be repaired is beyond normal operating distance of the closest Runco Authorized Service Center, or the repair requires the unit be returned to the Runco factory, it is the owner's responsibility to arrange for shipment of the product for repair. These arrangements must be made through the selling Runco Dealer. If this is not possible, contact Runco directly for a Return Authorization number and shipping instructions. Runco will return product transportation prepaid in the United States, unless no product defect is discovered. In that instance, shipping costs will be the responsibility of the owner.

COPYRIGHT AND TRADEMARKS:

© Copyright 2006 Runco International. This document contains proprietary information protected by copyright, trademark, and other intellectual property laws. All rights are reserved. No part of this manual may be reproduced by any mechanical, electronic or other means, in any form, without prior written permission of the manufacturer.

Reflection, Enhanced GEN3, DHD, Vivix, Virtual Cinema, CineWide, AutoScope, O-Path, CinOptx, LiveLink, CSMS, SuperOnyx and VirtualWide are trademarks of Runco International. All other trademarks and registered trademarks used in this document are the property of their respective owners.

Runco International products are manufactured under one or more of the following patents: US. Patent 6755540 and Other Patents Pending.

ADDITIONAL INFORMATION:

To locate the name and address of the nearest Runco Authorized Service Center, or for additional information about this Limited Warranty, please call or write:

RUNCO INTERNATIONAL, INC.
Attn: Customer Service Department
2900 Faber Street
Union City, CA 94587
Ph: (510) 324-7777
Fax: (510) 324-9300
Toll Free: (800) 23-RUNCO

RUNCO VIDEO-PRODUCT INFORMATION
RETAIN THIS INFORMATION FOR YOUR RECORDS

Model Purchased

Date

Serial Number

Runco Authorized Dealer Name

Address

City

State/Province

Postal Code

Phone

Fax

Safety Precautions

Thank you for your purchase of this quality Runco product! It has been designed to provide you with the quality of video that is expected in a home theater. This manual is your guide through the menus and operation. For the best performance, please read it carefully and keep it handy for future reference.



WARNING

This symbol is intended to alert the user to the presence of uninsulated "dangerous voltage" within the product's enclosure that may be of sufficient magnitude to constitute a risk of electric shock.



This symbol is intended to alert the user to the presence of important operating and maintenance (servicing) instructions in the literature accompanying the appliance.

CAUTION

To turn off main power, be sure to remove the plugs from power outlets. The power outlet socket should be installed as near to the equipment as possible, and should be easily accessible.

WARNING

TO PREVENT FIRE OR SHOCK HAZARDS, DO NOT EXPOSE THIS UNIT TO RAIN OR MOISTURE. ALSO DO NOT USE THIS UNIT'S POLARIZED PLUG WITH AN EXTENSION CORD RECEPTACLE OR OTHER OUTLETS, UNLESS THE PRONGS CAN BE FULLY INSERTED. REFRAIN FROM OPENING THE CABINET AS THERE ARE HIGH-VOLTAGE COMPONENTS INSIDE. REFER SERVICING TO QUALIFIED SERVICE PERSONNEL.

WARNING

This equipment generates, uses, and can radiate radio frequency energy and, if not installed and used in accordance with the Installation Manual, may cause harmful interference to radio communications. Operation of this equipment in a residential area may cause harmful interference, in which case the user will be required to correct the interference at his own expense.

Please read and follow the safety precautions listed below to ensure the equipment is free from damage, and to ensure that no injury will occur as a result of improper use.

- Do not insert any object, especially metal or liquids, into the plasma display.
- Do not place any objects containing water or any other liquid on top of the plasma display.
- Do not place the units in direct sunlight, near heaters or in extremely dusty or humid locations.
- Do not install this system outdoors or otherwise exposed to the elements.
- Do not place heavy objects on top of the plasma display.
- If the power cord is damaged or frayed in any way, electrical shock and/or fire may result. Do not place objects on the power cord, and keep the cord away from heat-emitting devices. Should the power cord become damaged in any way, please contact your Runco Dealer for a replacement cord.
- Do not remove the cover of the plasma display for any reason. If any problems arise with the unit, please contact a Runco Dealer or Runco International for service. Removing the covers will void the warranty.

Table of Contents

THREE YEAR LIMITED WARRANTY	iii
Safety Precautions	vi
1. Introduction	1
About This Manual	1
Target Audience	1
If You Have Comments About This Manual.....	1
Textual and Graphic Conventions	1
Using This Manual	2
Description, Features and Benefits	3
Key Features and Benefits	3
Parts List	4
2. Controls and Functions	5
CinemaWall at a Glance	5
Controls and Indicators.....	5
Connectors.....	7
CinemaWall Remote Control	9
3. Installation	11
Remote Control	11
Notes on Batteries	11
Notes on Remote Control Operation	11
Quick Setup	13
Installation Considerations	14
High-Altitude Operation	14
Mounting the CinemaWall on a Wall or Table Stand.....	14
Ambient Light	15
Ventilation	15
Other Considerations.....	16
Connections to the CinemaWall	17
Video Connections.....	17
Audio Connections	21
RS-232 Controller Connection	23
Cable Management	24

4. Operation	25
Turning on the Power	25
Changing the OSD Language	25
Selecting an Input Source	26
Viewing Input Signal Information	26
Setting the Computer Display Properties	26
Changing the Aspect Ratio	27
Using the On-Screen Menus	29
Main Menu.....	31
Picture	31
Screen.....	35
Set-Up.....	36
Option	38
Option (Installer Adjust Mode)	40
Using Picture-In-Picture (PIP)	44
Selecting a PIP Source	44
Swapping the Main and PIP Windows	45
Changing the PIP Position	45
Enlarging One Part of the Screen	46
5. Maintenance and Troubleshooting	47
Cleaning	47
Cleaning the Display Panel Body and Remote Control	47
Cleaning the Screen.....	47
Cleaning the Vents.....	47
Troubleshooting Tips	47
6. Serial Communications	49
RS-232 Connection and Port Configuration	49
Serial Command Syntax	49
Example	49
7. Specifications	61
CinemaWall Specifications	61
CinemaWall Dimensions	62
Computer/Video Signal Compatibility	63

List of Figures

2-1. CinemaWall Controls and Indicators	5
2-2. SP-42 Connector Panel.....	7
2-3. SP-42 Remote Control	9
3-1. Available Range of the Remote Control	11
3-2. Ventilation Requirements for Enclosure Mounting	15
3-3. RGB/Component Video (INPUT 1) Connection	17
3-4. ANALOG RGB OUT (INPUT 1) Connection.....	18
3-5. DVI-D (INPUT 2) Connection.....	18
3-6. Composite or S-Video (INPUT 3) Connection	19
3-7. Component Video (INPUT 4) Connection.....	20
3-8. DVI-D (INPUT 5) Connection.....	20
3-9. Connecting Audio Inputs	21
3-10. Audio Output Connection	22
3-11. Connecting Speakers	22
3-12. RS-232 Control System Connection.....	23
3-13. Installing the Cable Ties	24
4-1. CinemaWall OSD Menu Structure.....	30
4-2. Typical PLUGE Pattern for Adjusting Brightness	31
4-3. Typical Gray Bar Pattern for Adjusting Contrast	32
4-4. Typical Color Bar Pattern for Adjusting Color Saturation and Tint.....	33
4-5. Typical Test Pattern for Adjusting Sharpness.....	34
4-6. Audio System Functional Block Diagram	38
4-7. Picture Orientation.....	43
4-8. Viewing an Enlarged Area of the Display	46
7-1. CinemaWall Model SP-42 Dimensions (with Optional Table Stand)	62

Notes:

1. Introduction

This Owner's Manual describes how to install, set up and operate the Runco CinemaWall Flat-Panel Plasma Display Monitor (Model SP-42). Throughout this manual, the Runco CinemaWall Flat-Panel Plasma Display Monitor is referred to simply as the "CinemaWall."

Runco has prepared this manual to help home theater installers and end users get the most out of the CinemaWall.

Runco has made every effort to ensure that this manual is accurate as of the date it was printed. However, because of ongoing product improvements and customer feedback, it may require updating from time to time. You can always find the latest version of this and other Runco product manuals on-line, at www.runco.com.

Runco welcomes your comments about this manual. Send them to techpub@runco.com.

Text Conventions: The following conventions are used in this manual, in order to clarify the information and instructions provided:

- Remote control button identifiers are set in upper-case bold type; for example, "Press **EXIT** to return to the previous menu."
- Computer or control system input (commands you type or program into the control system) and output (responses that appear on-screen) is shown in monospace (fixed-width) type; for example: "To change the aspect ratio to Letterbox, send the command 02 2A 2A 53 5A 4D 53 30 33 03."
- All keys with functional names are initial-capped, set in bold type and enclosed in angle brackets. These keys are the following: **<Enter>**, **<spacebar>**, **<Ctrl>**, **<Esc>** and **<Tab>**.
- **<Enter>** indicates that you may press either the RETURN or ENTER key on your keyboard if it has both keys.

In addition to these conventions, underlining, boldface and/or italics are occasionally used to highlight important information, as in this example:



WARNING

*To prevent image retention (burn-in) on your display, **ALWAYS** use a screen saver and set it to the shortest possible time.*

1.1 About This Manual

◀ Target Audience

◀ If You Have Comments About This Manual...

◀ Textual and Graphic Conventions

Graphic Conventions: These symbols appear in numerous places throughout the manual, to emphasize points that you must keep in mind to avoid problems with your equipment or injury:



Tip

TIPS highlight time-saving short cuts and helpful guidelines for using certain features.



Note

NOTES emphasize text with unusual importance or special significance. They also provide supplemental information.



Caution

CAUTIONS alert users that a given action or omitted action can degrade performance or cause a malfunction.



WARNING

WARNINGS appear when a given action or omitted action can result in damage to the equipment, or possible non-fatal injury to the user.



DANGER!

DANGER appears when a given action can cause severe injury or death.

1.2 Using This Manual

Use the following table to locate the specific information you need in this manual.

If you need...	... Turn to page:
Information about obtaining service	iv
General information about the CinemaWall Flat-Panel Plasma Display Monitor	3
Installation instructions	11
First-time configuration instructions	25
Advanced configuration instructions	40
Troubleshooting tips	47
Specifications for the CinemaWall Flat-Panel Plasma Display Monitor	61

The CinemaWall Flat-Panel Plasma Display Monitor combines high-resolution quality and affordability into one package. It has all of the features that one has come to expect from a Runco product, including high-quality video processing, aspect ratio control and ease of use. The advanced Runco processing inside the CinemaWall combined with its high native resolution allows the most accurate scaling for all types of signals, including DVD (progressive or interlaced), all currently-available HDTV formats and computers.

For video originally made in film, the CinemaWall has built-in 3:2 pulldown for the sharpest and most artifact-free images possible. Like all Runco plasmas, it can be mounted on a wall, ceiling or placed on a tabletop and is bright enough for use in any lighting situation: its size is such that it can be the centerpiece of many home theaters.

The CinemaWall Flat-Panel Plasma Display Monitor offers 1024 x 768 resolution and includes Runco's discrete aspect ratio control with VirtualWide™ mode to fill a 16:9 screen with standard 4:3 images without loss of picture quality. Also included are discrete source selection, multi-language support and an RS-232 interface for whole-house or automated control system integration.

The CinemaWall Flat-Panel Plasma Display Monitor has been carefully engineered with ISF™ calibration standards for superb video performance. At less than five inches deep, it can be wall-mounted or used on a tabletop stand.

The CinemaWall offers these key features and benefits:

- 16:9 Native Resolution: 1024 x 768
- Screen Size (diagonal): 42 inches
- Multiple Aspect Ratios with VirtualWide™ Mode
- Less than 5 inches deep
- Dual DVI Inputs with High-bandwidth Digital Content Protection (HDCP)
- HDTV Compatible
- Exceptional detail and artifact-free video enhancement
- Vivix™ video processing with 3:2 film detection circuitry

1.3 Description, Features and Benefits

◀ Key Features and Benefits

Parts List ➤ Your CinemaWall is shipped with the following items. If any items are missing or damaged, please contact your Runco dealer or Runco Customer Service at (800) 23-RUNCO.

- CinemaWall Flat-Panel Plasma Display Monitor
- AC Power Cord
- Remote Control Unit and two (2), AA-size batteries
- Cleaning Cloth
- Cable Ties (2)
- Warranty information and registration card
- Runco CinemaWall Model SP-42 Owner's Operating Manual (this document)

Optional Accessories:

- Wall Mount Kit
- Table Stand

2. Controls and Functions

2.1 CinemaWall at a Glance

Figure 2-1 shows the locations of the CinemaWall controls, indicators and connectors.

← Controls and Indicators

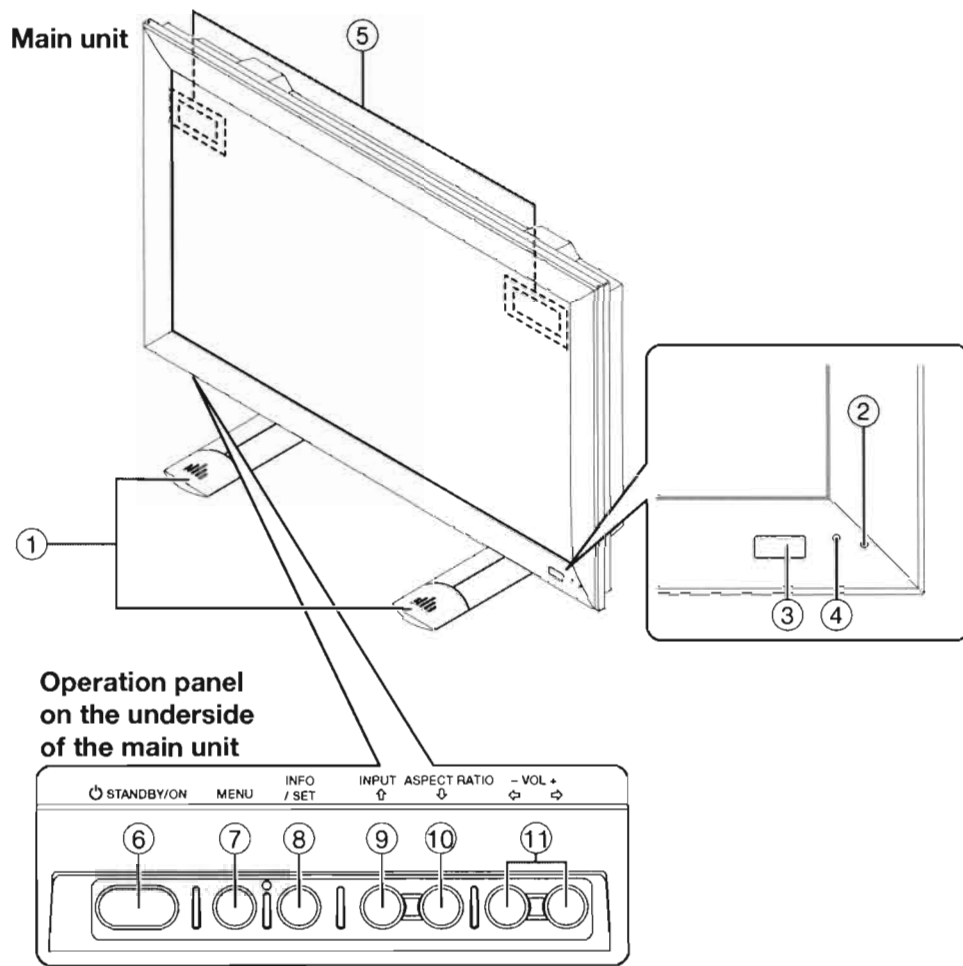

Figure 2-1. CinemaWall Controls and Indicators

1. **DISPLAY STAND**
Optional accessory for tabletop installations.
2. **REMOTE CONTROL SENSOR**
Receives the signals from the remote control.
3. **AMBIENT LIGHT SENSOR**
This sensor measures the light level in the viewing area; it is active when the Energy Mode is set to **Auto** (refer to **Energy Mode** on page 38 for more information).
4. **STANDBY/ON INDICATOR**
 - Lights green to indicate normal operation;
 - Flashes green (once per second) when the AUTO OFF feature is active.
 - Lights red to indicate that the CinemaWall is in standby mode;
 - Flashes green or red (twice per second) to indicate an error condition.
5. **HANDLES**
ALWAYS use the handles when carrying the unit.
6. **STANDBY/ON BUTTON (⏻)**
Press to put the display into operation or standby mode.
7. **MENU**
Press this button to show or hide the On-Screen Display (OSD) controls.
8. **INFO/SET**
When the OSD controls are visible on-screen, press this button to select an OSD sub-menu or confirm a changed setting.

When no OSD appears on-screen, press this button to display the currently-selected input, aspect ratio and input signal characteristics (resolution, timing etc.).
9. **INPUT/UP (▲)**
Press this button to switch inputs or move the cursor up in the current OSD menu.
10. **ASPECT RATIO/DOWN (▼)**
Press this button to change the aspect ratio (screen size) or move the cursor down in the current OSD menu.
11. **LEFT (◀) / VOL – and RIGHT (▶) / VOL +**
These decrease or increase the volume of sound from the speakers, or move the cursor left or right in the OSD mode.

◀ Connectors

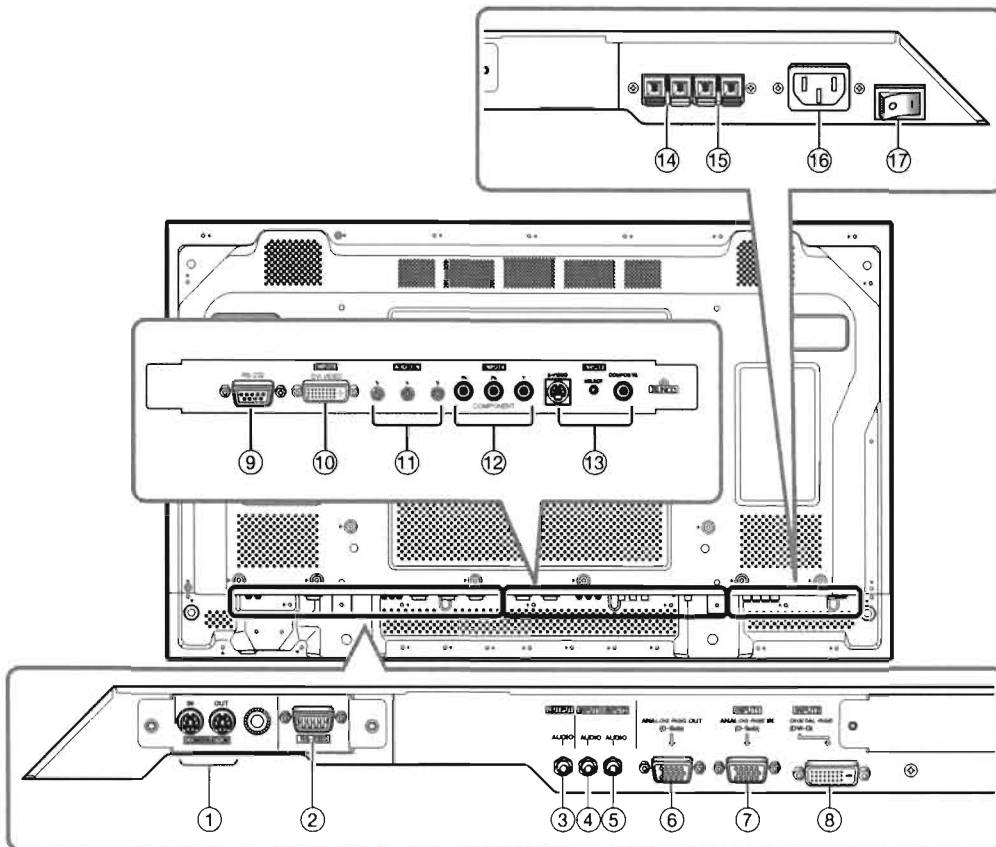

Figure 2-2. SP-42 Connector Panel

1. **COMBINATION IN/OUT**
Used to control multiple CinemaWall monitors collectively. Use a 6-pin, mini-DIN cable (all pins wired straight-through).
2. Not used.
3. **AUDIO (OUTPUT) (3.5-mm stereo mini jack)**
Used to output the audio of the selected source component connected to the plasma display to an AV amplifier or similar component. **The output level is fixed.**
4. **AUDIO (INPUT 1) (3.5-mm stereo mini jack)**
Connect this jack to the audio output connector(s) of the device connected to INPUT 1.
5. **AUDIO (INPUT 2) (3.5-mm stereo mini jack)**
Connect this jack to the audio output connector(s) of the device connected to INPUT 2.
6. **ANALOG RGB OUT (INPUT 1) (15-pin D-Sub)**
If desired, connect this output to the RGB input of a second display device.



Note

This output is not active when the CinemaWall is off or in standby mode.

7. **ANALOG RGB IN (INPUT 1) (15-pin D-Sub)**
For connecting components that have RGB or component output jacks such as a personal computer or external DTV decoder (a break out cable is needed for BNC-type connection).
8. **DIGITAL RGB (INPUT 2) (DVI-D, HDCP-compliant)**
VESA-standard digital video input from a personal computer, or digital video from a DVD player or HD set-top box.
9. **RS-232 (9-pin, female D-Sub)**
Connect the RS-232 output from your computer or automation/control system to this input.
10. **DIGITAL RGB (INPUT 5) (DVI-D, HDCP-compliant)**
This DVI input will process digital video 480p, 720p and 1080i signals (computer rates are not recommended).
11. **AUDIO (INPUT 5 / INPUT 4 / INPUT 3) (3.5-mm stereo mini jack)**
Used for external audio input from video sources connected to Inputs 5, 4 and 3.
12. **INPUT 4**
Interlaced or progressive component input (480p to 1080i, 50 or 60 Hz; 480i not recommended – use INPUT 3 instead).
13. **INPUT 3 (S-Video or Composite Video Input)**
For connecting a VCR, camcorder, laser disc player or DVD player. Use the push button between the two connectors to select S-Video or Composite Video on Input 3 (only one can be active at a time).
14. **EXTERNAL SPEAKER OUTPUT (RIGHT)**
For connection of an external right speaker. Connect a speaker that has an impedance of 6 ohms.
15. **EXTERNAL SPEAKER OUTPUT (LEFT)**
For connection of an external left speaker. Connect a speaker that has an impedance of 6 ohms.
16. **AC POWER INPUT**
Connect the CinemaWall to power here, using the included power cord.
17. **MAIN POWER SWITCH**
Connects or disconnects the CinemaWall from the AC power source.

Figure 2-3 shows the CinemaWall remote control. The paragraphs that follow describe its functionality.

2.2 CinemaWall Remote Control

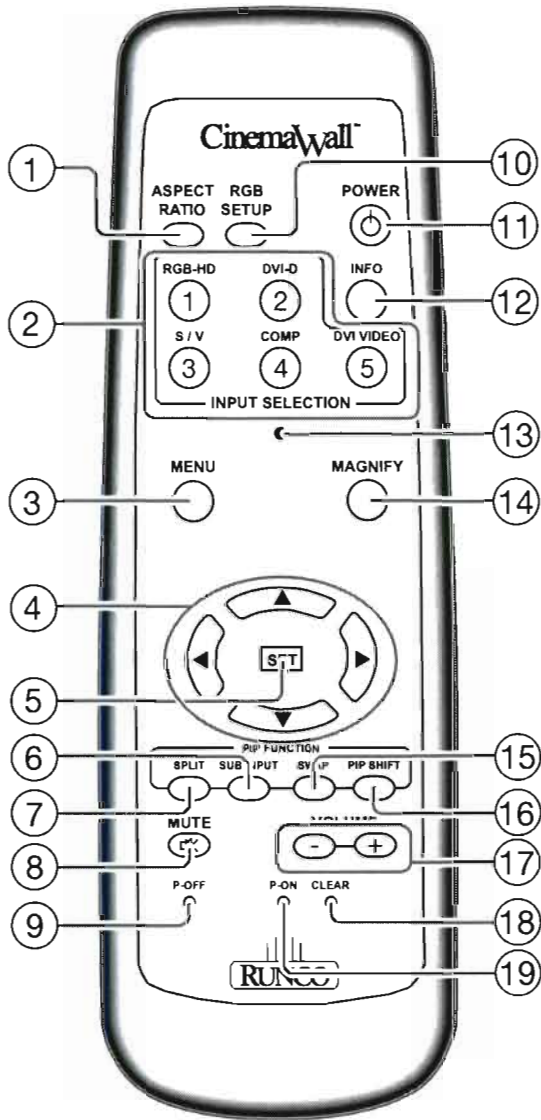

Figure 2-3. SP-42 Remote Control

1. **ASPECT RATIO**
Press this button repeatedly to select a display aspect ratio.
2. **INPUT SELECT**
Press one of these buttons to select an input.
3. **MENU**
Press this button to show or hide the OSD controls.
4. **Directional Buttons (▲ / ▼ / ◀ / ▶)**
Use these buttons to navigate the OSD menus and adjust various settings.
5. **SET BUTTON**
Press this button to adjust or enter various settings on the unit.
6. **SUB INPUT**
When using the Picture-in-Picture (PIP) feature, press this button repeatedly to select a sub-input source.
7. **SPLIT**
Press this button to change the PIP mode (picture-in-picture, side-by-side or off).
8. **MUTE**
Press this button to mute the speakers connected to the CinemaWall speaker outputs. Press it again to restore the sound.
9. **P-OFF (pin hole)**
Using a straightened paper clip or similar object, press this button to program a discrete IR code for powering off the CinemaWall into a control/automation system.
10. **RGB SETUP**
When using INPUT 1 to display images from a computer, press this button to automatically set the Position, Clock and Phase settings to their optimum values.
11. **STANDBY/ON (⏻)**
Press to put the display into operation or standby mode.
12. **INFO**
Displays currently-selected input, aspect ratio and signal timing information.
13. **INSTALLER ADJUST (pin hole)**
Used to access the INSTALLER ADJUST menus.
14. **MAGNIFY**
Press this button to select and enlarge one part of the screen image.
15. **SWAP**
When using the Picture-in-Picture (PIP) feature, press this button to replace the main screen with the sub-screen or vice versa.
16. **PIP SHIFT**
Press this button to change the position of the smaller PIP sub-window (lower right, upper right, lower left or upper left).
17. **VOLUME + / -**
Use these buttons to increase or decrease the volume of sound from the speakers.
18. **CLEAR (pin hole)**
Using a straightened paper clip or similar object, press this button to clear a screen maintenance program (refer to **Program Timer** on page 40).
19. **P-ON (pin hole)**
Using a straightened paper clip or similar object, press this button to program a discrete IR code for powering on the CinemaWall into a control/automation system.

3. Installation

To install batteries in the remote control:

1. Remove the battery cover from the back of the remote control.
2. Insert the batteries included with the remote control. Ensure that the polarities correctly match the \oplus and \ominus markings inside the battery compartment.
3. Replace the battery cover.

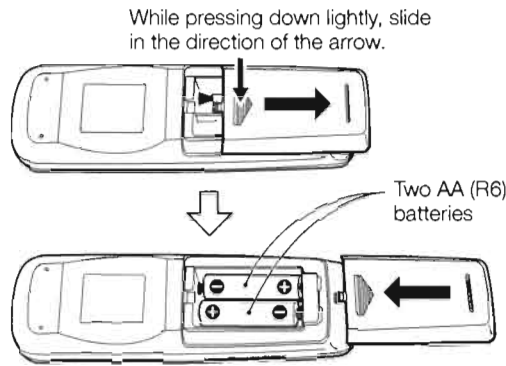

3.1 Remote Control

- When installing batteries, make sure that the battery polarities are correct.
- Do not mix an old battery with a new one or different types of batteries.
- If you will not use the remote control for a long time, remove the batteries to avoid damage from battery leakage.

◀ Notes on Batteries

The remote control can be used to control the CinemaWall within the ranges shown in Figure 3-1.

◀ Notes on Remote Control Operation

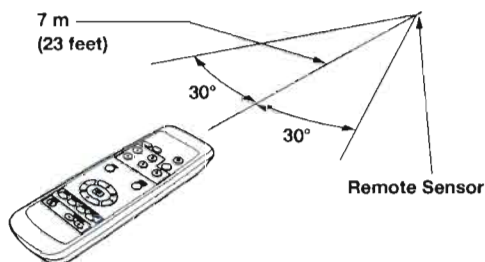

Figure 3-1. Available Range of the Remote Control

- Do not drop the remote control or expose it to moisture or high temperature.
- The remote control may malfunction under a fluorescent lamp. If that occurs, move the plasma display away from the fluorescent lamp.
- Make sure that there is nothing obstructing the infrared beam between the remote control and the IR receiver on the plasma display.



Note

The signal from the remote control can be reflected by walls or other surfaces.

- If the effective range of the remote control decreases, or it stops working, replace the batteries with new ones.
- Ambient conditions may possibly impede the operation of the remote control. If this happens, point the remote control at the plasma display and repeat the operation.

Table 3-1 gives a quick overview of the CinemaWall installation process. The sections following this one provide detailed instructions.

3.2 Quick Setup



Note

Installation should be performed by a qualified custom video installation specialist.

Table 3-1. Installation Overview

Step	Procedure	For Details, refer to page...
1	Mount the CinemaWall on a wall or table stand	14
2	Connect signal sources to the CinemaWall	17
3	Connect external controller to RS-232 port (optional)	23
4	Apply power to the CinemaWall	25
5	Change the OSD language, if desired	25
6	If using the CinemaWall with a computer, adjust computer display properties	26
7	Display calibration: adjust the following for each input , starting with Component (Input 4 and/or Input 1); save settings when finished: <ul style="list-style-type: none"> • Aspect ratio • Brightness • Contrast • Color level • Tint • Sharpness 	31 through 37

3.3 Installation Considerations

Proper installation of your CinemaWall will ensure the highest possible picture quality. Whether you are installing the CinemaWall temporarily or permanently, you should take the following into account to ensure that it performs optimally.

High-Altitude Operation ➤

Due to the design of all plasma glass panels made by every manufacturer, and the interaction between ambient air pressure and the plasma gases contained inside of the panel, reliable operation of your plasma display cannot be assured during operation at certain high-altitude locations.

Runco has found this plasma monitor to operate reliably at altitudes of up to 6000 MSL (mean sea level). At elevations higher than this, each panel may react differently, depending upon the altitude, air pressure, humidity and other meteorological factors.

For this reason, Runco International makes no warranties or claims as to the reliable operation of the CinemaWall at altitudes greater than 6000 feet above sea level. If you are planning to use this product at a location above 6000 feet, please contact Runco technical support for further information.

Mounting the CinemaWall on a Wall or Table Stand ➤

To install the CinemaWall, you will need either an optional table stand or wall-mounting kit. The CinemaWall cannot be installed on its own.

If you do decide to wall-mount the CinemaWall, ensure that the wall-mount bracket is installed according to the instructions included with it. The wall must be capable of supporting a redundant weight factor three (3) times the weight of the display, or be reinforced.

Runco recommends that this be done by a custom installation specialist.



Note

Use only a Runco-approved wall-mount kit or table stand that is specifically designed for your display.

You can attach your optional mounts or stand to the CinemaWall in either of two ways:

- While it is upright.

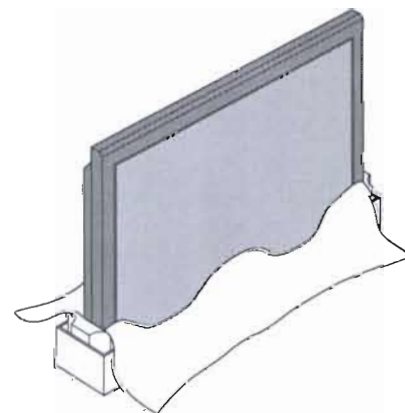

- As it lies flat with the screen face down. Place the protective sheet, which was wrapped around the plasma monitor when it was packaged, between the screen and your work surface to avoid scratching or otherwise damaging the screen surface.

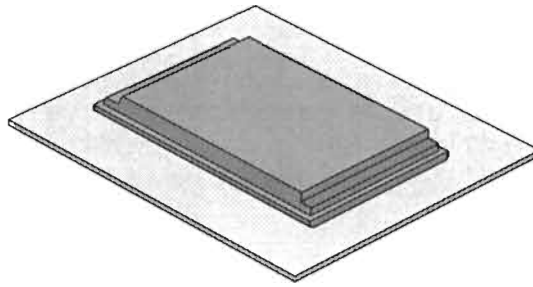

In general, minimize or eliminate light sources directed at the display. Contrast ratio in your images will be noticeably reduced if light directly strikes the display, such as when a shaft of light from a window or floodlight falls on the image. Images may then appear washed out and less vibrant.

◀ **Ambient Light**

If you are mounting the CinemaWall in an enclosure, leave at least 2 inches (50 mm) of space on all sides between it and surrounding objects, as shown in Figure 3-2. This allows heat to disperse, maintaining the proper operating temperature.

◀ **Ventilation**

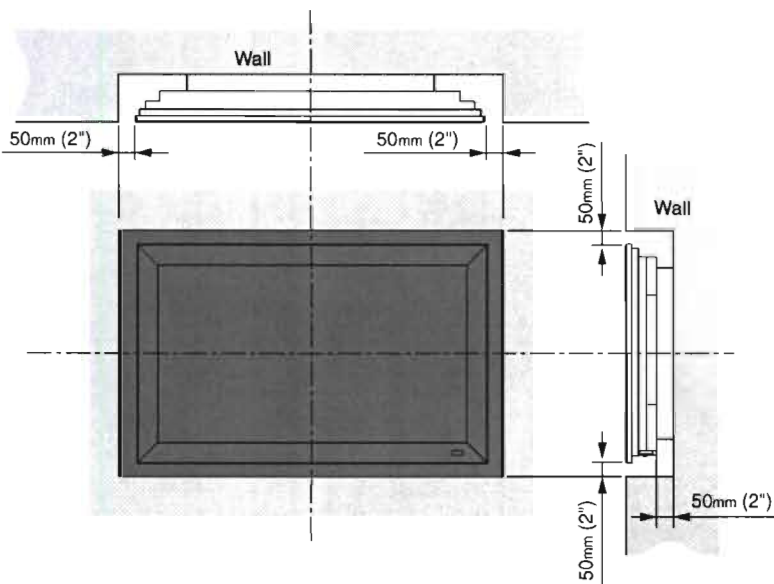

Figure 3-2. Ventilation Requirements for Enclosure Mounting

- Other Considerations** ► Other considerations and tips that can help improve your installation, avoid damage and prolong operating life:
- Keep the ambient temperature constant and below 35°C (95°F). Keep the display away from heating and/or air conditioning vents. Changes in temperature may cause drifts in the display circuitry, which may affect performance.
 - Keep the CinemaWall away from devices that radiate electromagnetic energy such as motors and transformers. Common sources of these include slide projectors, speakers, power amplifiers and elevators.
 - Handle the unit carefully when installing it. When carrying it, use the built-in handles; DO NOT touch or hold the screen face.
 - Set the unit away from heat, excessive dust, and direct sunlight.
 - Protect the inside of the unit from liquids and small metal objects. In case of accident, unplug the power cord and have it serviced by an authorized Runco Service Center.
 - Do not hit or scratch the panel surface as this causes flaws on the surface of the screen.
 - For correct installation and mounting it is strongly recommended to use a trained, authorized dealer.
 - To avoid sulfurization, it is strongly recommended not to place the unit in a dressing room in a public bath or hot spring bath.

Proceed as follows to connect the CinemaWall to your video sources, external controller(s) – if present – and AC power.

When connecting your equipment:

- Turn off all equipment before making any connections.
- Use the correct signal cables for each source.
- Ensure that the cables are securely connected. Tighten the thumbscrews on connectors that have them.

Connect your video sources to the CinemaWall as shown in Figure 3-3 and described in the sections that follow.

RGB/Component Video (INPUT 1) Connection: Connect your personal computer or DTV decoder with an RGB or component output to the ANALOG RGB IN input on the CinemaWall, as shown in Figure 3-3.

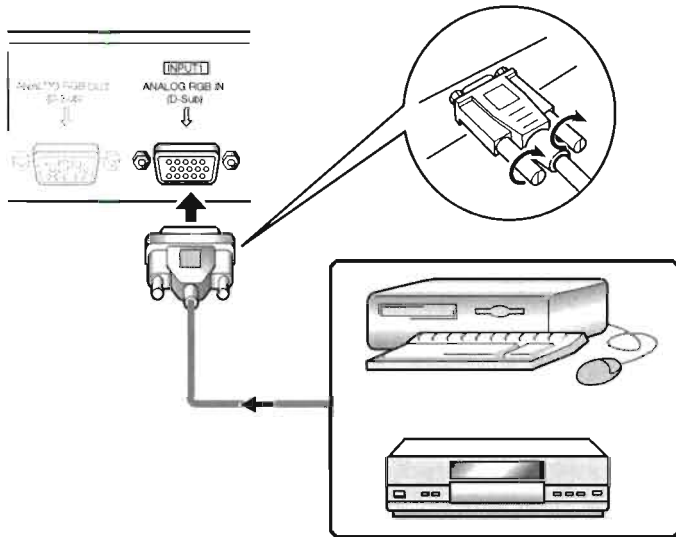

Figure 3-3. RGB/Component Video (INPUT 1) Connection



Note

1. The CinemaWall accepts "sync-on-green" and composite sync RGB signals on INPUT1, as well as separate sync (RGBHV) signals. For more computer signal compatibility information, refer to **Computer/Video Signal Compatibility** on page 63.
2. Some Macintosh computers may require a Macintosh video adapter. Contact your nearest authorized service center or dealer.
3. INPUT 1 supports the VESA Display Data Channel (DDC 1/2B) standard. This standard provides "Plug and Play" capability; the display and a VESA DDC-compatible computer communicate their setting requirements, allowing for quick and easy setup.

In order for Plug and Play to work correctly, you must turn on the CinemaWall before you turn on the connected computer.

3.4 Connections to the CinemaWall

◀ Video Connections

ANALOG RGB OUT (INPUT 1) Connection: The CinemaWall has an RGB output for looping the signal received at INPUT 1 out to a second RGB display device. Connect the second display device to the ANALOG RGB OUT connector as shown in Figure 3-4.

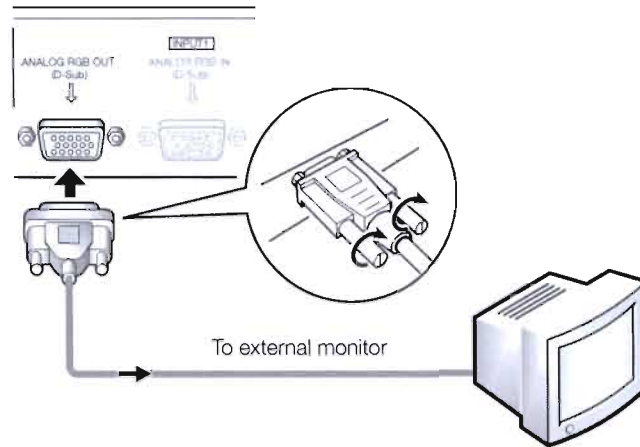

Figure 3-4. ANALOG RGB OUT (INPUT 1) Connection



Note

A video signal is not output when the CinemaWall is powered off or in standby mode.

DVI-D (INPUT 2) Connection: The CinemaWall has a DVI-D input for connecting a personal computer, DVD player, DTV decoder or any other device with a DVI output. Connect such devices to INPUT 2 as shown in Figure 3-5. Use a 24-pin, DVI-D (digital only) cable.

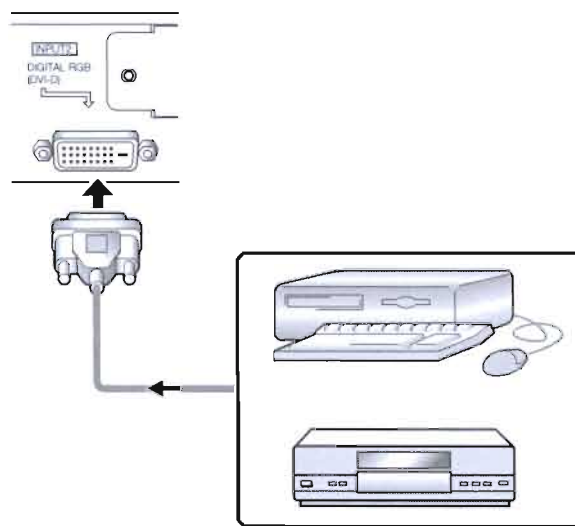

Figure 3-5. DVI-D (INPUT 2) Connection

**Tip**

Use the DVI inputs whenever possible. This ensures the highest video quality because the signal is carried in the digital domain throughout the entire signal path, from source component output into the display.

**Note**

1. For computer signal compatibility information, refer to **Computer/Video Signal Compatibility** on page 63.
2. INPUT 2 supports the VESA Display Data Channel (DDC 2B) standard. This standard provides "Plug and Play" capability; the display and a VESA DDC-compatible computer communicate their setting requirements, allowing for quick and easy setup.

In order for Plug and Play to work correctly, you must turn on the CinemaWall before you turn on the connected computer.

Composite/S-Video (INPUT 3) Connections: The CinemaWall has S-Video and Composite video inputs for connecting a VCR, camcorder, laser disc player, DVD player or other standard-definition (480i) source. Connect such devices to INPUT 3 as shown in Figure 3-6.

To switch between the Composite and S-Video input, press the SELECT button between the two connectors.

**Note**

You cannot switch from the Composite to the S-Video input (or vice versa) using the remote control.

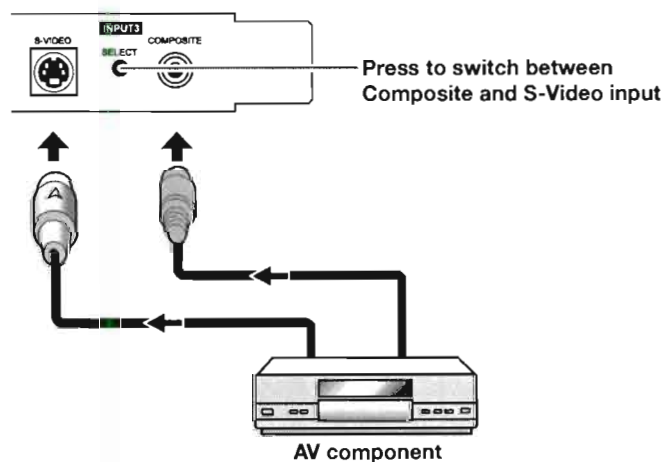

Figure 3-6. Composite or S-Video (INPUT 3) Connection

Component Video (INPUT 4) Connection: If you have a DVD player or DTV decoder with a component (YPbPr) output, connect it to INPUT 4, as shown in Figure 3-7.



Tip

For best results, use INPUT 4 for 480p and higher-resolution sources only. (Use INPUT 3 for standard-definition (480i) sources).

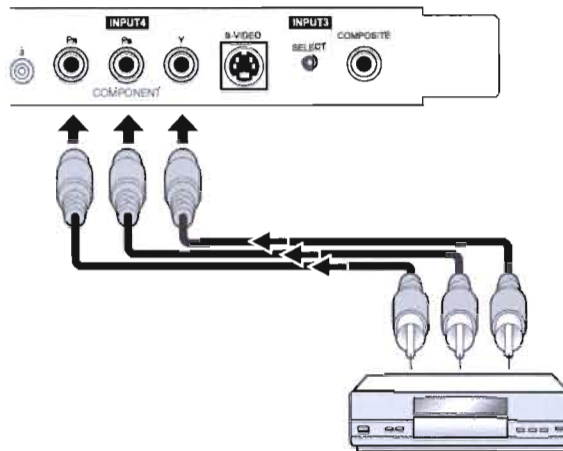

Figure 3-7. Component Video (INPUT 4) Connection

DVI-D Video (INPUT 5) Connection: The CinemaWall has a DVI-D input for connecting a DVD player, DTV decoder or any other device with a DVI output (computer signals are not supported). Connect such devices to INPUT 5 as shown in Figure 3-8. Use a 24-pin, DVI-D (digital only) cable.

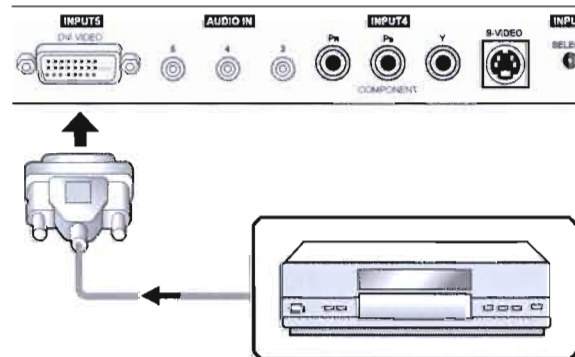
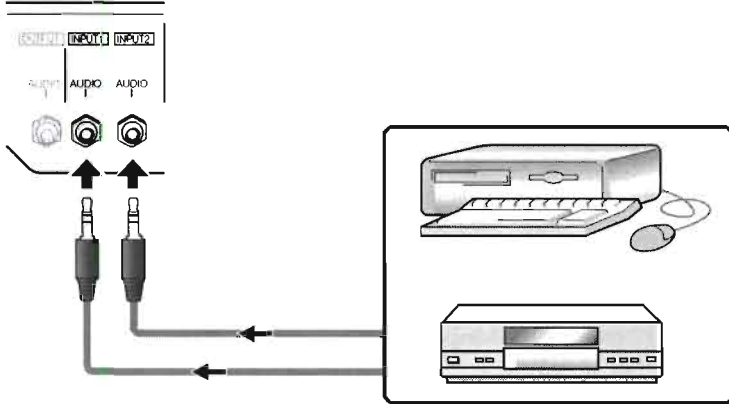

Figure 3-8. DVI-D (INPUT 5) Connection

Audio Inputs: The CinemaWall has five (5), stereo audio inputs; each one corresponds to a video input. Connect the audio outputs from your source components to these inputs using a cable with a stereo miniplug at the CinemaWall end and the appropriate connector(s) (stereo miniplug or dual RCA plugs) at the other end; see Figure 3-9.

◀ **Audio Connections**

INPUT 1 / INPUT 2



INPUT 5 / INPUT 4 / INPUT 3

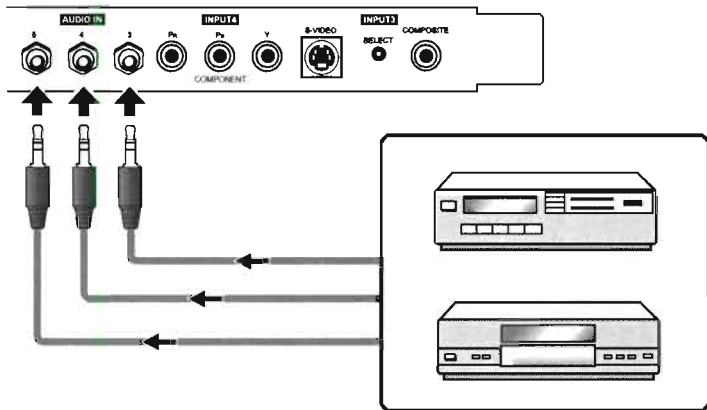

Figure 3-9. Connecting Audio Inputs

Audio Output: The CinemaWall has a stereo audio output for connection to an external A/V receiver or powered speakers. The audio signal corresponding to the selected video input is output to both the speakers and this audio output.



Note

The audio output level is fixed. (The volume and mute controls affect only the speaker outputs.)

Use a stereo miniplug to connect the CinemaWall stereo audio output to your external audio equipment; see Figure 3-10.

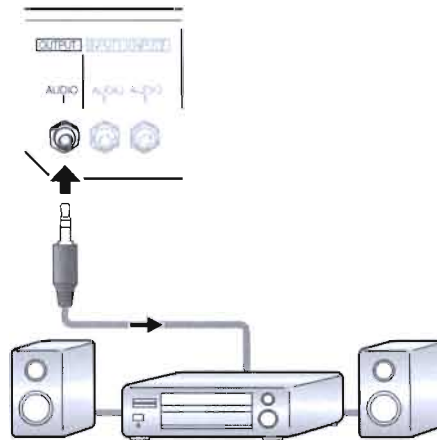
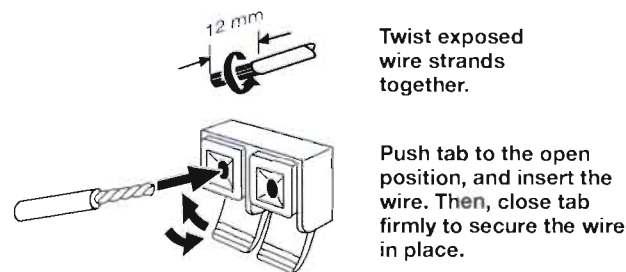

Figure 3-10. Audio Output Connection

Speakers: The CinemaWall has an internal, 8W per channel stereo amplifier that can drive a pair of stereo speakers. Connect the \oplus (positive) and \ominus (negative) speaker wires to the EXT SPEAKER terminals on both the LEFT and RIGHT channels; see Figure 3-11.

Maintain the correct polarity. For more information, refer to the owner's manual for your speakers.



Twist exposed wire strands together.

Push tab to the open position, and insert the wire. Then, close tab firmly to secure the wire in place.

Figure 3-11. Connecting Speakers

Use a 9-pin, straight-through RS-232 cable to connect a PC or home theater control/automation system (if present) to the RS-232 port (located next to INPUT 5) on the CinemaWall; see Figure 3-12.

◀ **RS-232 Controller Connection**

For more information about using this connection, refer to **Serial Communications** on page 49.

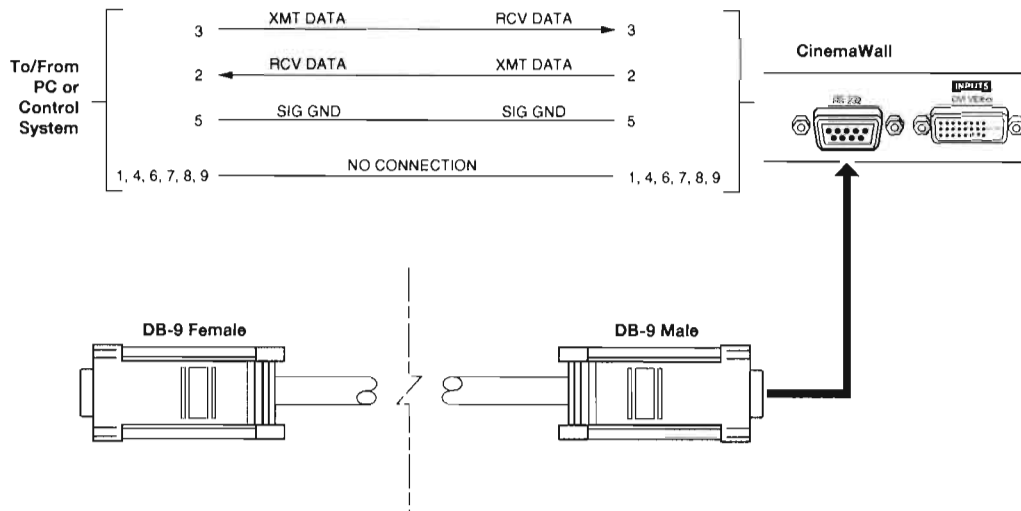

Figure 3-12. RS-232 Control System Connection

Cable Management ➤ To minimize cable clutter, you can use the cable ties provided with the CinemaWall to bundle the video, control and power cables at the back of the display. Install the cable ties as shown in Figure 3-13. Cables can be routed to the right or left.



Note

Do not allow excessive stress to be placed on the ends of cables.

* As viewed from the rear of the display.

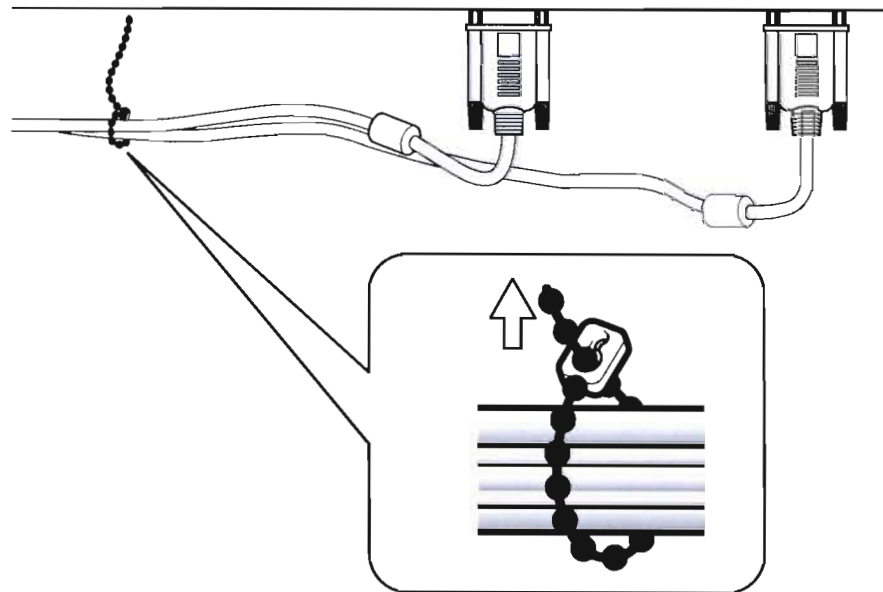
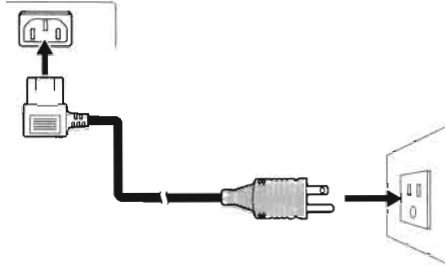

Figure 3-13. Installing the Cable Ties

4. Operation

1. Turn on your source components.
2. Plug the female end of the power cord into the AC receptacle on the rear of the CinemaWall (AC 100V ~ 240V). Connect the other end to your AC power source.
3. Set the main power switch at the rear of the CinemaWall (see Figure 2-2) to the “on” position. Its power indicator lights red.
4. Press the **POWER** button on the underside of the CinemaWall (see Figure 2-1) or the remote control (see Figure 2-3). The power indicator lights solid green.
5. After a brief warm-up period (approximately 10 seconds), the CinemaWall will display an image.



4.1 Turning on the Power

The CinemaWall OSD language is initially set to English, but can also display the menus in German (Deutsch), French (Français), Spanish (Español) or Italian (Italiano). To change the OSD language:

1. Press **MENU**.
2. Press **▶** repeatedly to select **Option** from the Main Menu.
3. Press **SET** to select **Language**.
4. Press the right- or left-arrow button (**◀** or **▶**) to highlight the desired language and press **SET**. The change takes effect immediately.

4.2 Changing the OSD Language

4.3 Selecting an Input Source

To select an input source, press a numbered button on the remote control corresponding to that input.

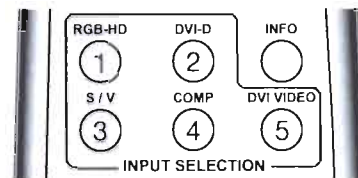

4.4 Viewing Input Signal Information

Press **INFO** on the remote control to have the CinemaWall display the currently-selected input, signal timing information (frequency and polarity) and aspect ratio. This information stays on-screen for about five seconds.



4.5 Setting the Computer Display Properties

To maximize image quality when using the CinemaWall with a personal computer, you may need to adjust the display properties of your computer's video card. To do this on a Microsoft® Windows®-based PC:

1. Choose Settings from the Windows Start Menu and click on "Control Panel."
2. Double click on the **Display** icon.
3. Click the **Settings** tab on the display dialog box.
4. Adjust the resolution to 1024x768 pixels.

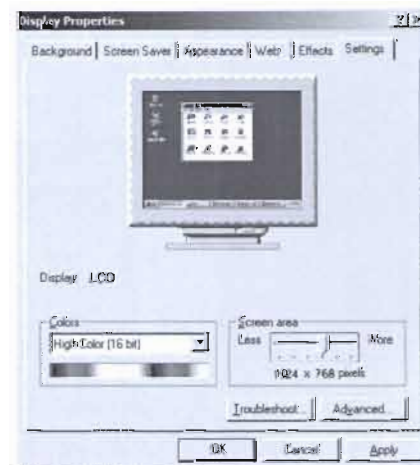

- Click the **Advanced** button and click the **Monitor** tab on the dialog box. Set the vertical frequency to 60Hz and click **OK**.

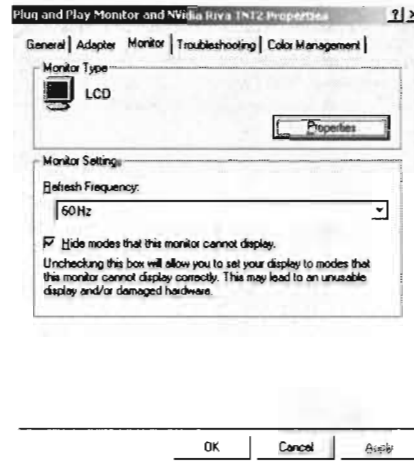

Note

- The native resolution of the SP-42 is 1024 x 768. Other horizontal or vertical resolutions may be scaled upward or downward to fit the display.
- With most computers, you can get the best picture at 1024 x 768 @ 60Hz.



WARNING

To prevent image retention (burn-in) on your display, **ALWAYS** use a screen saver and set it to the shortest possible time.

RGB Setup (Input 1 only): After adjusting the computer's display properties, press the **RGB SETUP** button on the remote control to have the CinemaWall automatically adjust the size, position, and quality of the displayed image.

DVI Setup (Input 2 only): After adjusting the computer's display properties, configure Input 2 for plug-and-play operation; refer to **DVI Setup (Input 2 only)** on page 37.

To change the aspect ratio (size and shape) of the projected image, press the **ASPECT RATIO** button repeatedly on the remote control. Select the appropriate aspect ratio for the type of program material being viewed; refer to Table 4-1.



Note

- Not all aspect ratios are available on some inputs. For example, "PIX BY PIX" is available only with computer signals and Standard 4:3 is not available on Input 5.
- The aspect ratio selection is saved independently for each input.

4.6 Changing the Aspect Ratio

Table 4-1. Aspect Ratio Settings







Aspect Ratio	Description	
Anamorphic	 <p>16:9 Image on 16:9 Screen</p> <p>4:3 Image on 16:9 Screen</p>	<p>Select Anamorphic to view 16:9 DVDs and HDTV programs in their native aspect ratio. 4:3 images are stretched horizontally to fit a 16:9 screen.</p>
Standard (4:3)	 <p>Active Image Area (4:3)</p>	<p>Standard 4:3 scales the input signal to fit in the center of the 16:9 screen. 4:3 is the aspect ratio used by computer monitors, standard television programming and most VHS video cassettes.</p>
Letterbox	 <p>Letterbox Image on 16:9 Screen</p>	<p>In Letterbox mode, the image is stretched vertically; the top and bottom portions are "blacked off."</p>
VirtualWide		<p>A 4:3 image is scaled NON-linearly (more on the sides than in the center) to fit a 16x9 screen.</p>
Virtual Cinema	 <p>2.35:1 Image on 16:9 Screen</p> <p>2.35:1 Image on 16:9 Screen with Virtual Cinema</p>	<p>A 2.35:1 image is stretched anamorphically in both directions to fill a 16:9 image. The 2.35:1 image is cropped on all sides.</p>

Table 4-1. Aspect Ratio Settings (continued)

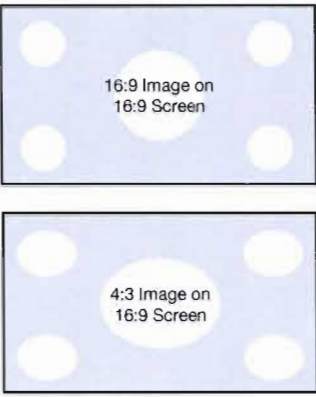
Aspect Ratio	Description	
14:9	 <p data-bbox="431 438 546 480">Active Image Area (14:9)</p>	14:9 scales the input signal to fit in the center of the 16:9 screen.
PIX BY PIX	 <p data-bbox="406 661 571 736">800x600 Image within 1024x768 Display</p>	Select PIX BY PIX to display a computer screen image in the center of the display with no re-sizing. Resolutions lower than 1024x768 will result in a black border around the image; with higher resolutions, the image will be cropped.

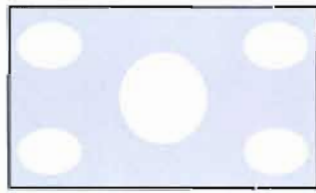
To use the on-screen menus:

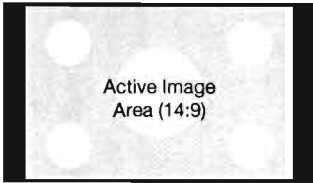
1. Press **MENU** on either the remote control or the CinemaWall control panel (see Figure 2-1) to display the Main Menu. Or, using a straightened paper clip or similar object, press the Installer Adjust menu button located below the Input 4 button on the remote control (see Figure 2-3) to display the Installer Adjust menu.



Note

The Installer Adjust menu is intended for use by authorized, trained service personnel only.

2. To select a sub-menu, use the right- or left-arrow buttons (◀, ▶) to highlight it.
3. Use the up- or down-arrow buttons (▲, ▼) to select the setting you want to change.
4. Do one of the following:

Press **SET** repeatedly until the desired value appears;

– OR –

Press **SET** to display an on-screen sidebar or sub-menu. Press the right- or left-arrow button (◀, ▶) to change that setting. (If you do not do this within five seconds, the sidebar disappears.) Press **SET** to confirm the setting.

5. If the current menu has a "RETURN" command, highlight it and press **SET** to return to the previous menu. Or, press **MENU** to exit the OSD menu system.

The CinemaWall OSD menus are arranged hierarchically, as shown in Figure 4-1. Depending on the selected input source and signal characteristics, some menu options may not be available.

4.7 Using the On-Screen Menus

Picture (Note 1)	Contrast		<i>(Installer Adj.: 0 ... +255) (Note 1)</i>	
	Brightness (Note 2)	-30 ... 0 ... +30		
	Color			
	H. Sharpen	0, +1, +2 ... +15	<i>(PC signals only)</i>	
	V. Sharpen			
	Tint	-30 ... 0 ... +30	<i>(Installer Adj.: 0 ... +60)</i>	
	Sharpness	-7, ... 0 ... +7	<i>(Installer Adj.: 0 ... +15)</i>	
	White Balance	R. Gain	0 ... +255	
		G. Gain		
		B. Gain		
		R. Offset		
		G. Offset		
		B. Offset		
		White Bal. Reset		
	Return			
	Color Chart	Red	0 ... +60	
		Yellow		
		Green		
		Cyan		
		Blue		
Magenta				
C. Chart Reset		Yes / No		
Return				
Gamma	1.8, 1.9, 2.0, 2.2, 2.3 or 2.4			
Factory	Yes / No			
Screen (Note 1)	H. Shift	-64 ... +63	<i>(Installer Adj.: +64 ... +191)</i>	
	V. Shift			
	Frequency Adjust	-128 ... +127	<i>(PC signals only; Auto Setup Mode must be OFF)</i>	
	Phase Adjust	-16 ... +15		
	H. Size			
	V. Size	0 ... +64		
	Image Reset	Yes / No		
Set-Up	Color Temp.	Low, Mid-Low, Middle, Mid-High or High		
	Auto Off	On / Off		
	Video NR	Off, Low, Middle or High		
	MPEG Filter			
	Chroma EE	On / Off		
	Film Mode			
	Color Space	RGB, Comp. 1 or Comp. 2		
	DVI Setup (Input 2 only)	Plug / Play	Video / PC	
		Black Level	Low / High	
	Signal	Auto, 480p ... 1080i or 840x480 ... 1376x768 (choices vary per input)		
	Brt. Enhance	On / Off		
	Sub Volume	0 ... +20		
	Option	Language	English, Français, Español, Deutsch or Italiano	
Energy Mode		Auto, Average, Level 1, Level 2 or Level 3		
Time/Date		Present Time	DST: On / Off	Day, Hour, Minute
		Program Timer	On / Off	Return
PDP Mgmt.		Orbiter	Off, Type 1, Type 2 or Type 3	
		Soften	Off, 1, 2, 3 or 4	
Auto Setup Mode		On / Off		
Auto Function		Off or Input 1		
Program Timer		Date	MON, TUE ... SUN (once only at the selected day/time) or *MON, *TUE ... *SUN (weekly) or *** (daily)	
		On	00:00 ... 23:59	
		Off	00:00 ... 23:59	
		Input	Input 1 ... Input 5 or "*" (last)	
Pattern		White, Inverse, Orbiter or "*" (last)		
Test Pattern		Off, Inverse, White, Red, Green, Blue or Yellow		
Sidebar Adjust		R. Adjust	0 ... +255	
		G. Adjust		
		B. Adjust		
Default				
Baud Rate	1200, 2400, 4800, 9600, 19200 or 38400			
ID Number	01h - FFh or ALL			
Fan Speed	Auto or Max			
OSD	Display	On / Off		
	Size	Small or Large		
Front L.E.D.	On / Off			
ISF Settings	Normal or ISF ccc			
Runco Pro	Underscan	On / Off		
	Display Profile	Normal, Pure, Monotone or High-Crit.		
	Signal Type	Motion, Still or Non-Std.		
FRC	Normal or Scaler			
Power On Mode	Input	Input 1, 2, 3, 4 or 5 or Last		
	Volume	0, 1, 2 ... 42 or Last		
	Off			
Seamless Switch	On	Select 1 / Select 2: Input 1 - 5		
Picture Orient.	Flip H, Flip V, Flip HV or Off			
Function Reset	Yes / No			

Notes:

1. Menu items in *italics* appear only when the CinemaWall is in Installer Adjust mode. Picture and Screen settings made in Installer Adjust mode define the "zero point" for normal, "User-mode" adjustments. For example, setting Contrast in Installer Adjust mode defines the white level that results when Contrast is set to 0 in "User" mode.
2. When adjusting the Brightness (black level) for RGB and Component HD (480p/720p/1080i) signals, use the "User mode" Brightness control. For 480i and digital video sources, either Brightness control ("User" mode or Installer Adjust mode) can be used.

Figure 4-1. CinemaWall OSD Menu Structure

The Main Menu is the starting point for accessing all CinemaWall functions. Some menu options are available only in “Installer Adjust” mode.

Use the controls in the Picture menu to calibrate your CinemaWall for optimum picture quality.

The CinemaWall has been designed to incorporate setup and calibration standards established by the Imaging Science Foundation (ISF). The ISF has developed carefully crafted, industry-recognized standards for optimal video performance and has implemented a training program for technicians and installers to use these standards to obtain optimal picture quality from Runco video display devices. Accordingly, Runco recommends that setup and calibration be performed by an ISF-certified installation technician.

All signal types require separate processing. Therefore, you need to calibrate each input separately. Runco recommends calibrating the CinemaWall inputs in the following order:

1. Component (Input 4)
2. S-Video (Input 3)
3. Composite Video (Input 3)
4. Analog RGB (Input 1)
5. DVI/Digital RGB (Input 2 / Input 5)

Although it may be possible to obtain satisfactory picture quality using the naked eye and regular program material, Runco recommends using the following calibration tools for best results:

- External test pattern source – Ovation Multimedia, Video Essentials or AVIA test DVD (or equivalent).
- A blue filter (provided with many test DVDs), for color level and tint adjustments.

Connect your test pattern source to the input that you are calibrating and proceed as follows. **Perform the adjustments in the order listed here.**

Brightness: On your external test pattern source, select a PLUGE pattern. (PLUGE is an acronym for “Picture Line-Up Generation Equipment.”) Figure 4-2 shows a typical PLUGE pattern.

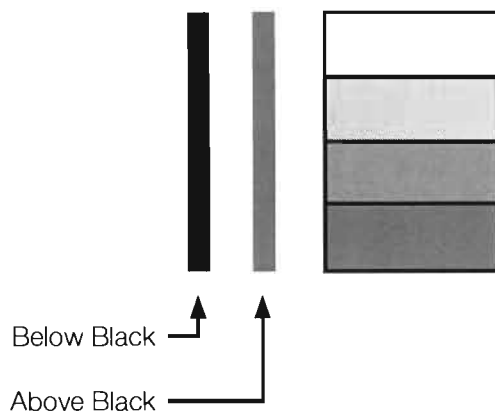
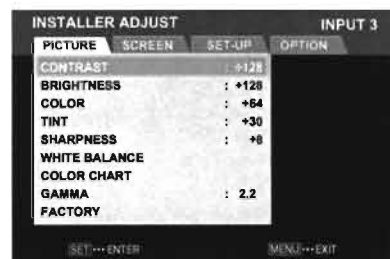

Figure 4-2. Typical PLUGE Pattern for Adjusting Brightness

◀ **Main Menu**

◀ **Picture**



PLUGE patterns vary but generally consist of some combination of black, white and gray areas against a black background. The example above includes two vertical bars and four shaded boxes.

Select Brightness from the Picture menu. Using the left- and right-arrow (◀ ▶) buttons, adjust the brightness so that:

- The darkest black bars disappear into the background.
- The dark gray areas are barely visible.
- The lighter gray areas are clearly visible.
- The white areas are a comfortable level of true white.
- The image contains only black, gray and white (no color).

Contrast: On your external test pattern source, select a stepped, gray-bar pattern like the one shown in Figure 4-3.

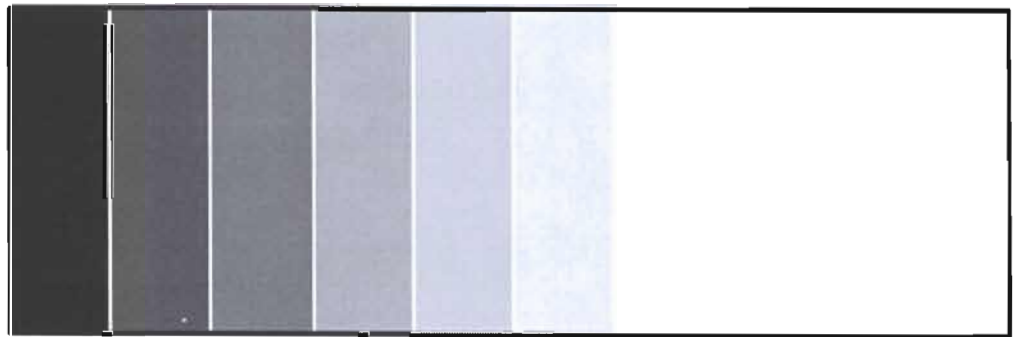

Figure 4-3. Typical Gray Bar Pattern for Adjusting Contrast

Select Contrast from the Picture menu. Using the left- and right-arrow (◀ ▶) buttons, adjust the contrast to a point just below which the white rectangle starts to increase in size.



Note

Brightness and contrast controls are interactive. A change to one may require a subtle change to the other in order to achieve the optimum setting.

Color Saturation: On your external test pattern source, select a color bar pattern like the one shown in Figure 4-4.

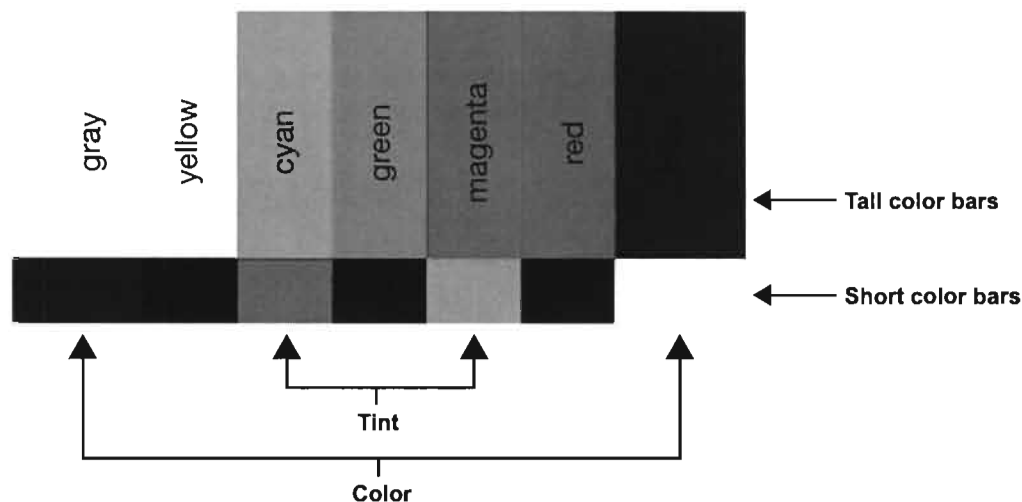
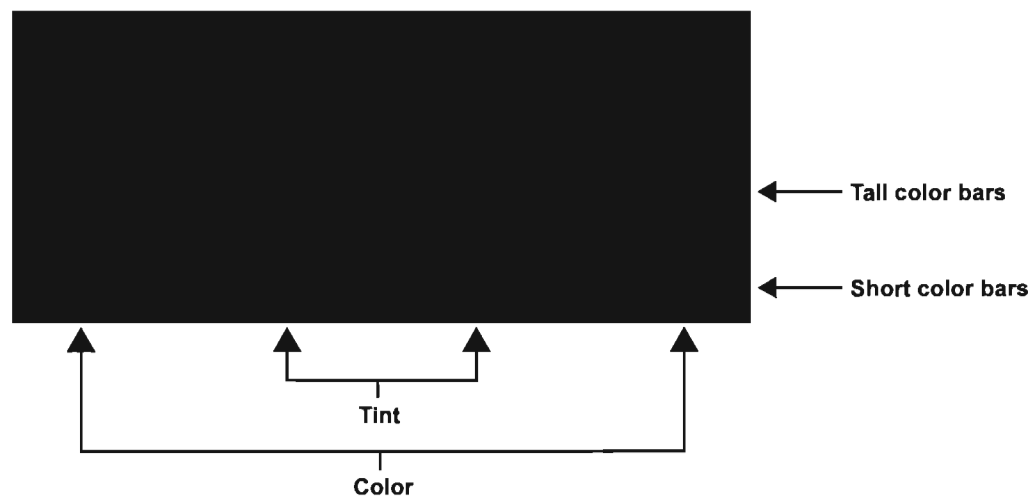

Figure 4-4. Typical Color Bar Pattern for Adjusting Color Saturation and Tint

Select Color from the Picture menu. While looking at the color bar pattern through a blue filter, adjust the color saturation level until the outermost (gray and blue) color bars appear to be a single shade of blue:



H. Sharpen/V. Sharpen (computer signals only): Select H. Sharpen or V. Sharpen from the Picture menu to enhance the level of detail (in the horizontal or vertical direction respectively) in a computer screen image.

Tint: Tint or “hue” is essentially the ratio of red to green in the color portion of the image. When tint is decreased, the image appears redder; when it is increased the image appears greener. To set the tint, select Tint from the Picture menu. While looking at the color bar pattern through a blue filter, adjust the tint level until the cyan and magenta color bars (on either side of the green bar) appear to be a single shade of blue.



Note

Like the brightness and contrast controls, the color and tint controls are interactive. A change to one may require a subtle change to the other in order to achieve the optimum setting.

Sharpness: "Sharpness" is the amount of high-frequency detail in the image. To adjust sharpness, select Sharpness from the Picture menu and press **SET**. On your external test pattern source, select a pattern like the one shown in Figure 4-5. Adjust as needed, looking for white edges around the transitions from black to gray and different sized lines in the "sweep" patterns at the top and bottom. Lower the sharpness setting to eliminate them.

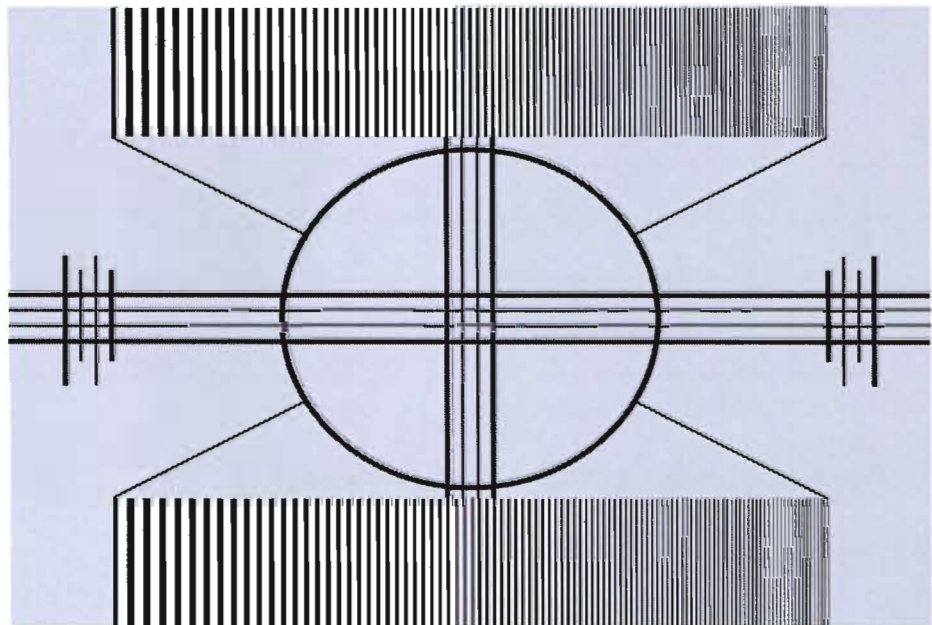
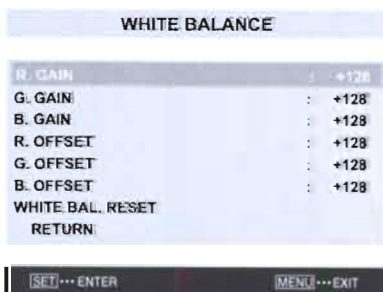

Figure 4-5. Typical Test Pattern for Adjusting Sharpness



White Balance (Installer Adjust mode): Select White Balance from the Installer Adjust/Picture menu to remove any trace of color from the white areas of the image.

- **Gain:** Use the Gain controls to correct color imbalances in the bright areas of the image. A good way to do this is to use a test pattern consisting mostly of solid white areas, such as an 80 IRE "window" pattern. If the white areas contain traces of red, green or blue, decrease the Gain for that color.
- **Offset:** Use the Offset controls in the White Balance sub-menu to correct color imbalances in the dark areas of the image. A good way to do this is to use a test pattern consisting mostly of dark gray areas, such as a 30 IRE "window" pattern. If the gray areas contain traces of red, green or blue, decrease the Offset for that color.

To reset the white balance settings to the factory default values, select **White Bal. Reset**. Then, press **◀** to highlight YES and press **SET**.

Select **Return** to exit the White Balance menu.

Color Chart (Installer Adjust mode): Select Color Chart from the Picture menu to adjust the color density for each of the six primary colors: red, yellow, green, cyan, blue and magenta. Changing these settings for a primary color alters the hue of that color and affects the gamut (range) of possible colors. For example, changing the value for red moves the color closer to either yellow or magenta, which in turn affects all displayed colors having a red component.

To reset the color gamut settings to the factory default values, select **C. Chart Reset**. Then, press **◀** to highlight YES and press **SET**.

Select **Return** to exit the Color Chart menu.

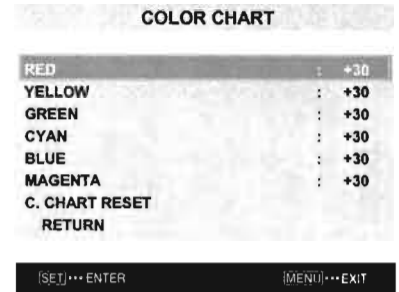

Gamma (Installer Adjust mode): The Gamma control determines how gray shades are displayed between minimum input (black) and maximum input (white) for all signals. A good gamma setting helps to optimize blacks and whites while ensuring smooth transitions for the "in-between" values utilized in other gammas.

Unlike brightness and contrast controls, Gamma allows you to lighten or darken the overall tone of your images without changing the extremes. All images will be more vibrant while still showing good detail in dark areas.

The default Gamma setting of 2.2 is appropriate for most typical home theater environments.

Factory: To reset all picture quality settings for the current input to the default, installer-adjusted values (or factory defaults, if in Installer Adjust mode), select **Factory** from the Picture menu. Then, press **◀** to highlight YES and press **SET**.

Image Position: Use the up- or down-arrow buttons (**▲**, **▼**) to highlight **Image Position**. Then, press **SET** and use the left- and right-arrow buttons (**◀**, **▶**) to shift the image horizontally; use the up- or down-arrow buttons (**▲**, **▼**) to shift the image vertically.

V Shift (Installer Adjust mode): Use the up- or down-arrow buttons (**▲**, **▼**) to highlight **V Shift**. Then, press **SET** and use the right-arrow button (**▶**) to shift the image up; use the left-arrow button (**◀**) to shift the image down.

H Shift (Installer Adjust mode): Use the up- or down-arrow buttons (**▲**, **▼**) to highlight **H Shift**. Then, press **SET** and use the right-arrow button (**▶**) to shift the image to the right; use the left-arrow button (**◀**) to shift the image to the left.

Frequency Adjust (Input 1 only): Use the up- or down-arrow buttons (**▲**, **▼**) to highlight **Freq. Adj.**. Then, press **SET**. The Frequency Adjust control adjusts the CinemaWall's internal clock frequency in small increments to match that of the incoming signal. Use it to reduce or eliminate letter breakup, flickering or other "noise" in a computer screen image.

Phase Adjust (Input 1 only): Use the up- or down-arrow buttons (**▲**, **▼**) to highlight **Phase Adj.**. Then, press **SET**. Use the Phase Adjust control to correct color misalignment or flickering text in a computer screen image.

◀ Screen



Note

Frequency Adjust and Phase Adjust are adjustable only when Auto Setup Mode (in the Option menu, described later in this section) is set to OFF.

V Size (Installer Adjust mode): Use the up- or down-arrow buttons (▲, ▼) to highlight V Size. Then, press **SET** and use the right-arrow button (▶) to increase the height; use the left-arrow button (◀) to decrease it.

H Size (Installer Adjust mode): Use the up- or down-arrow buttons (▲, ▼) to highlight H Size. Then, press **SET** and use the right-arrow button (▶) to increase the width; use the left-arrow button (◀) to decrease it.

Image Reset: To reset all screen settings for the current input to the default, Installer Adjust mode values, select **Image Reset** from the Screen menu. Then, press ◀ to highlight YES and press **SET**.

Set-Up ▶

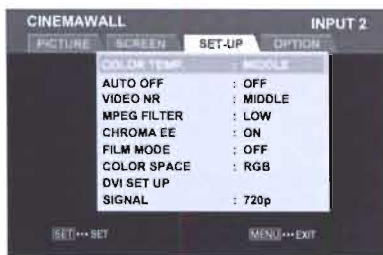

Color Temperature: To adjust the color temperature, select **Color Temperature** from the Set-Up menu. (Color temperature defines the “color of gray.”) Use the left- and/or right-arrow buttons to select LOW, MID-LOW, MIDDLE, MID-HIGH or HIGH. The default setting, MIDDLE, is appropriate for most situations. Higher settings produce a “bluer” picture; lower ones cause the image to appear more red.

Auto Off: When using the CinemaWall with a computer, set **Auto Off** to ON to have the CinemaWall go into standby mode when no source signal is present on the current input. (A warning message appears on-screen for approximately eight seconds before this occurs.) To return to normal operating mode from the Auto Off standby mode, select the input with the remote control or operate your computer.

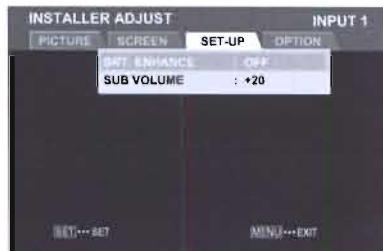

When **Auto Off** is disabled (OFF), the CinemaWall remains in normal operating mode, regardless of the presence or absence of an input sync signal.



Note

1. If the computer is turned off or not properly connected to the CinemaWall, the system is set to the off state.
2. For instructions on using the computer's power management features, refer to the instructions for your computer.

The STANDBY/ON indicator at the front of the CinemaWall indicates the status of the power management function, as described in Table 4-2.

Table 4-2. Power Management Indications

Power management mode	STANDBY/ON Indicator	Power management operating status	Description	Turning the picture back on
ON	Solid green	Not activated.	Horizontal and vertical synchronizing signals are present from the computer.	Picture already on.
OFF	Flashing green	Activated.	Horizontal and/or vertical synchronizing signals are not present from the computer.	Press a key on the keyboard or move the mouse. The picture reappears.

Video NR: To apply Digital Noise Reduction (DNR) to the input signal, select Video NR from the Set-Up menu. Noise reduction is useful for improving the signal-to-noise ratio of video signals.

Use the left- or right-arrow buttons to select the desired amount of noise reduction, keeping in mind that higher settings (which reduce high frequencies) may also “soften” the image.

MPEG Filter: Use the MPEG Filter to reduce or eliminate so-called “mosquito noise” in MPEG-compressed video signals (digital broadcasts or DVDs). Set it to LOW, MIDDLE or HIGH, as needed to minimize distortion around the edges of moving objects, moving artifacts around edges and/or blotchy noise patterns superimposed over the objects.

Chroma EE: Use the Chroma EE control to correct *chroma delay* in a Composite, S-Video or Component video source. Chroma delay in an image causes color shifts to occur to the left of the vertical edge transitions, producing artificial shadows or a “halo” effect. If necessary, set Chroma EE to ON to eliminate them.

Film Mode: When you enable Film Mode, the CinemaWall automatically detects and optimizes the display of interlaced video signals that originated from film. To disable Film Mode, set it to OFF.

**Note**

Film Mode can only be used on input signals with a 60-Hz refresh rate.

Color Space: To ensure proper color reproduction, select **Color Space** from the Set-Up menu and set it as follows:

- Select **RGB** for RGB input signals from a computer or video deck.
- Select **COMP. 1** for component input signals less than 720p, such as from a DVD player.
- Select **COMP. 2** for higher-resolution component input signals (720p or above, such as from an HD tuner).

DVI Setup (Input 2 only): Select **DVI Setup** from the Set-Up menu to configure Input 2 for “plug-and-play” operation with a computer, and select the appropriate black level.

- **Plug/Play:** If the Input 2 source is a computer, set this to **PC**. Otherwise, set it to **Video**.
- **Black Level:** This control compensates for incoming elevated black levels present in certain video signals. Generally, the CinemaWall automatically determines the best setting according to the incoming video signal type. For some types of video, you may want to override the setting. Set it to LOW if blacks appear elevated (dark gray). If blacks appear “crushed” (too dark), set it to HIGH.

Signal: The CinemaWall automatically identifies PC signals and video signals according to the frequency of the input signal, and identifies the resolution of a PC signal.

In most cases, setting **Signal** to **Auto** works well. However, if the displayed image is unstable or distorted, select **Signal** from the Set-Up menu and select a specific signal format. The available choices vary for each input.

Brt. Enhance (Installer Adjust mode): To improve and enhance the brightness of the center of the screen, select **Brt. Enhance** from the Set-Up menu and set it to ON. This reduces the brightness of the outer areas of the display by about 3 to 5%, relative to the center. For uniform brightness over the entire screen area, set **Brt. Enhance** to OFF.

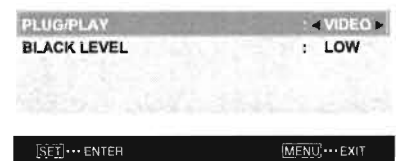
DVI SETUP

Sub Volume (Installer Adjust mode): Select **Sub Volume** from the Set-Up menu to adjust the audio input level for the current source. Do this for all sources, as needed to prevent sudden, drastic changes in sound volume when switching inputs.

For example, if a DVD player is connected to Input 4, a computer is connected to Input 1 and the audio output of the DVD player is fixed at a much higher level than that of the computer, reduce the Sub Volume for Input 4.

The Sub Volume control affects the current input only; the front-panel and remote volume controls are “master” controls; see Figure 4-6.

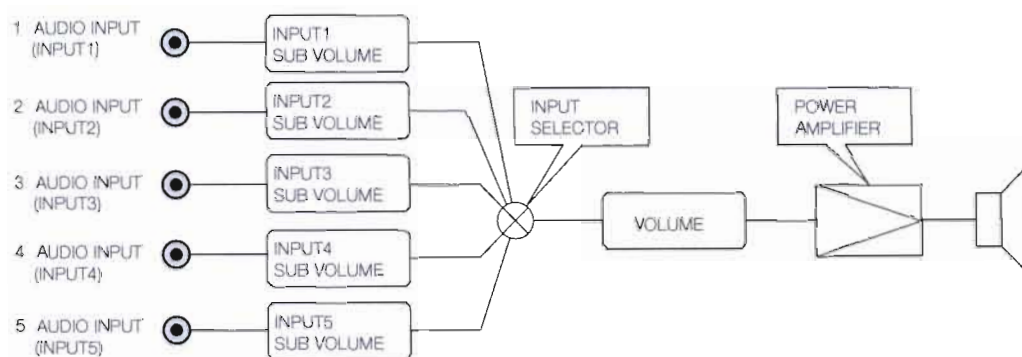
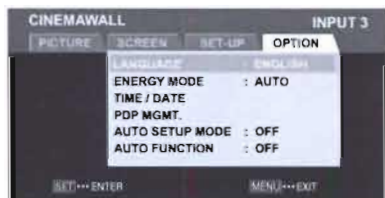

Figure 4-6. Audio System Functional Block Diagram

Option ➤ **Language:** Refer to **Changing the OSD Language** on page 25.



Energy Mode: Select **Energy Mode** from the Option menu to reduce power consumption and panel deterioration by limiting brightness of the screen. You can choose to limit brightness according to the input signal or in response to the ambient light level.

- Select **AVERAGE** to limit brightness in accordance with the input signal to produce a bright, easily viewed image.
- Select **LEVEL 1** to limit brightness in accordance with the input signal. Power consumption is less than that used in **AVERAGE** mode.
- Select **LEVEL 2** to limit brightness in accordance with the input signal. Power consumption is less than that used in **LEVEL1** mode.
- Select **LEVEL 3** to set the brightness at fixed level, regardless of input signal level (useful for preventing screen aging due to image burn).
- Select **AUTO** to have the CinemaWall adjust the brightness automatically in response to ambient lighting conditions, to optimize picture quality.

Time/Date: Select **Time/Date** from the Option menu to set the CinemaWall’s internal clock (time of day and day of the week) and turn the screen maintenance feature on or off.

- **Present Time:** To set the internal clock, highlight **Present Time** and press **SET**. Then, use the right- or left-arrow buttons (◀, ▶) to set the time. Press **SET** again when you are finished.
- **Program Timer:** Set **Program Timer** to **ON** to enable the CinemaWall’s screen maintenance feature, which lets you replace the normal source signal with a white field, an inverse image or an “orbiting” image. This occurs according to the schedule you establish using the Program Timer menu in Installer Adjust mode (refer to **Program Timer** on page 40).

Select **Return** to exit the Time/Date menu.

PDP Mgmt: Select **PDP Mgmt.** from the Option menu to configure the image burn-in prevention settings on the CinemaWall.

- **Orbiter:** Select **Orbiter** from the PDP Mgmt. menu to set the picture shift.
 - **OFF:** Orbiter mode does not function.
 - **TYPE 1:** The image size is reduced so the entire image remains in the display area while orbiting.
 - **TYPE 2:** The image is enlarged so there are no black bands in the display area while orbiting.
 - **TYPE 3:** The image size is unchanged.

**Note**

1. When TYPE 1 or TYPE 2 is selected, the image movement is continuous; TYPE 3 causes the image to move one pixel at a time.

2. The Orbiter does not function while the MAGNIFY feature is in use.

- **Soften:** Select Soften from the PDP Mgmt. menu to reduce edges (color transitions) and soften the image.
 - **OFF:** Turns the SOFTEN function off.
 - **1, 2, 3, 4:** Activates the SOFTEN setting. Higher numbers create a “softer” image.

Auto Setup Mode: The CinemaWall can automatically adjust the position, frequency and phase of incoming computer signals for optimum picture quality whenever the display is turned on, or when a different input or input signal type is selected. To enable this feature, select **Auto Setup Mode** from the Option menu and set it to ON.

**Note**

*Under some conditions – such as when the input signal consists of mostly dark colors – Auto Setup may not produce the desired results. If this occurs, set Auto Setup Mode to OFF and manually adjust the image position, frequency and phase; refer to **Screen** on page 35.*

Auto Function: The CinemaWall can automatically switch to Input 1 when an image signal is detected at that input. To enable this feature, select **Auto Function** from the Option menu and set it to INPUT 1.

After Auto Function causes a switch to Input 1, if the input signal is no longer detected, the input source reverts to the previously-selected input.

**Note**

Auto Function is currently supported on Input 1 only. The input signal must be RGB with composite or separate sync; Auto Function will not work with sync-on-green RGB or component signals.

When Auto Function is active, selecting an input manually causes Auto Function to be temporarily disabled. If you cycle power to the CinemaWall, Auto Function becomes active again.

Option (Installer Adjust Mode)

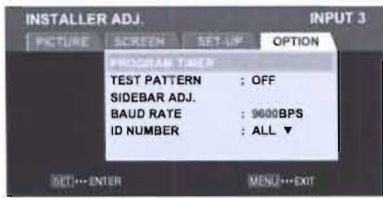

Program Timer: When in Installer Adjust mode, select **Program Timer** from the Option menu to program the screen maintenance features of the CinemaWall to operate at regular intervals. This is useful for preventing image burn-in.

You can program the CinemaWall to switch inputs and/or replace the normal source signal with a white field, an inverse image or an “orbiting” image. You can specify a time of day and day of the week when you want this to take place.

To set up a screen maintenance program:

1. Press **SET** to select the DATE field for the first program. Press ▲ or ▼ to select one of the following:
 - SUN, MON, TUE, WED, THU, FRI or SAT for a program that runs once only on the next occurrence of that day.
 - * for a program that runs daily.
 - *SUN, *MON, *TUE, *WED, *THU, *FRI or *SAT for a program that runs weekly on that day.
2. Press **SET**, then ► followed by **SET** again to set the program start time.
3. Press ▲ or ▼ to set the hour component of the start time.
4. Press ►, then ▲ or ▼ to set the minute component of the start time.
5. Press **SET**, then ► followed by **SET** again to set the program end time (repeat steps 3 and 4).
6. Press **SET**, then ► followed by **SET** again to specify an input associated with this program. Choose “-” to specify the input that was active when the CinemaWall was last powered off.
7. Press **SET**, then ► followed by **SET** again to select the PATTERN field for this program. Press ▲ or ▼ to select one of the following:
 - Choose “-” to specify the function that was active when the CinemaWall was last powered off.
 - Choose WHITE to display a white field.
 - Choose INVERSE to display an inverse image.
 - Choose ORBITER to display an “orbiting” image.
8. Press **SET**.
9. Repeat steps 1 through 8 as desired to create additional screen maintenance programs.

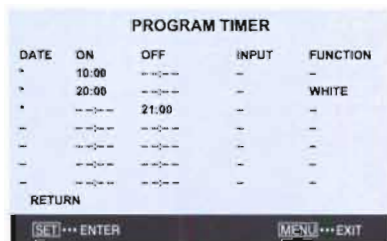

To clear a screen maintenance program, move the cursor to the DATE field and press **CLEAR** on the remote control, using a straightened paper clip or similar object.

Select **Return** to exit the Program Timer menu.

Test Pattern: Select **Test Pattern** from the Option menu to display an inverse of the normal picture on-screen, or a single color. Use this feature to repair burned-in areas of the display.

Press **SET** repeatedly to select INVERSE or a single color to display. Then, press **MENU**. To select a different pattern or return to the normal picture, press the Installer Adjust menu button, select Option, then select Test Pattern. Press **SET** repeatedly to select OFF or another pattern.

Sidebar Adjust: Select **Sidebar Adjust** from the Option menu to adjust the color of the sides of the screen when the Aspect Ratio is set to Standard 4:3 or 14:9 (refer to Table 4-1). The range is from 0 to +255 for each color component (red, green and blue); the default setting is +80 (gray).

Baud Rate: This menu item is reserved for future use.

ID Number: The ID Number uniquely identifies the CinemaWall in multiple-panel or video-wall installations. It is used to address serial commands to a specific panel when two or more are daisy-chained together via the COMBINATION IN/OUT connectors (see Figure 2-2). For installations with only one CinemaWall, leave the ID Number set to **01**.

Fan Speed: Select **Fan Speed** from the Option Menu to control the operation of the CinemaWall's cooling fan.

In most cases, the default Fan Speed (AUTO) will maintain the correct operating temperature. If the CinemaWall frequently turns off due to overheating, or in certain high-altitude operating environments, you may need to change this setting to MAX.

OSD: Select OSD from the Option menu to set options relating to OSD menu appearance and behavior.

- **Display:** When you select an aspect ratio or input with the remote control, the CinemaWall displays your selection on-screen. When you adjust the volume or press **MUTE** on the remote control, a sidebar appears as a visual indicator of the level.

To prevent the display of these items, select **Display** from the OSD menu and set it to OFF.

- **Size:** Select Size from the OSD menu to change the OSD menu size (SMALL or LARGE).

Select **Return** to exit the OSD menu.

Front L.E.D.: Select **Front L.E.D.** from the Option menu to change the behavior of the front-panel STANDBY/ON indicator LED (Figure 2-1). When set to ON, the LED indicates operating status as follows:

- Lights green to indicate normal operation;
- Flashes green (once per second) when the AUTO OFF feature is active;
- Lights red to indicate that the CinemaWall is in standby mode;
- Flashes green or red (twice per second) to indicate an error condition.

When set to OFF, the LED lights red when the CinemaWall is in standby mode; otherwise, it is off.

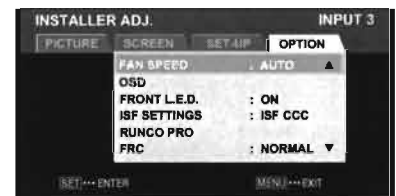

ISF Settings: The CinemaWall provides two “color modes,” NORMAL and ISF CCC. This allows you to create two, independent sets of image quality settings and switch from one to the other by selecting a color mode.

Select **ISF Settings** from the Option menu. Then, press **SET** to select either NORMAL or ISF CCC. Any subsequent changes to image quality settings are stored and can be recalled by selecting that color mode.



Note

The ISF CCC color mode is pre-set to approximately 3,200K.

Runco Pro: Select **Runco Pro** from the Option menu to access these advanced image processing settings.

- **Underscan:** Underscan causes the outer edge of the display to appear beyond the normal effective data area for a video signal.

To use Underscan, select it from the Runco Pro menu and set it to ON. Then, exit the menu system and use the **ASPECT RATIO** remote control button to select Underscan mode.
- **Display Profile:** Select NORMAL or PURE to see the normal color gamut. Select MONOTONE to remove all color information from the image. Select HIGH CNT to increase the color temperature by approximately 2,000K.
- **Signal Type:** For most source material types, the appropriate **Signal Type** setting is MOTION. However, with certain interlaced and/or composite video images with few or no moving objects, STILL or NON-STD may yield better results.

Select **Return** to exit the Runco Pro menu.

FRC: Select **FRC** from the Option menu to enable frame rate conversion. Set FRC to NORMAL if you notice and want to minimize motion blur when viewing source material that originated from film. If frame rate conversion is not needed, set FRC to SCALER.

Power On Mode: Select **Power On Mode** from the Option menu to specify which input signal is displayed when you turn on the CinemaWall. You can also specify an initial audio volume level.

You can select a specific input or volume level (0 to 42). Or, select LAST to have the CinemaWall set the input and volume to what they were the last time it was turned off.

Seamless Switch: This feature allows for high-speed switching between any two CinemaWall inputs using the **SWAP** button on the remote control. To enable it, select **Seamless Switch** from the Option menu and set it to ON. Then, specify the two inputs you want to associate with this feature in the SELECT1 and SELECT2 fields.

By default, Input 1 and Input 2 are selected, so that when Input 1 is active, pressing **SWAP** switches to Input 2 and vice versa.

Select **Return** to exit the Seamless Switch menu.



Note

Seamless Switch is not available when using PIP.

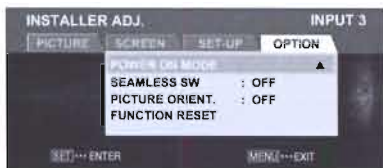

Picture Orient.: Select **Picture Orient.** to change the displayed image orientation to suit the installation method; see Figure 4-7. For example, if the CinemaWall is suspended from a ceiling, you may want to mount it upside down and run the cables upward (toward the ceiling) to make them less visible. In this case, you would select “FLIP HV.”

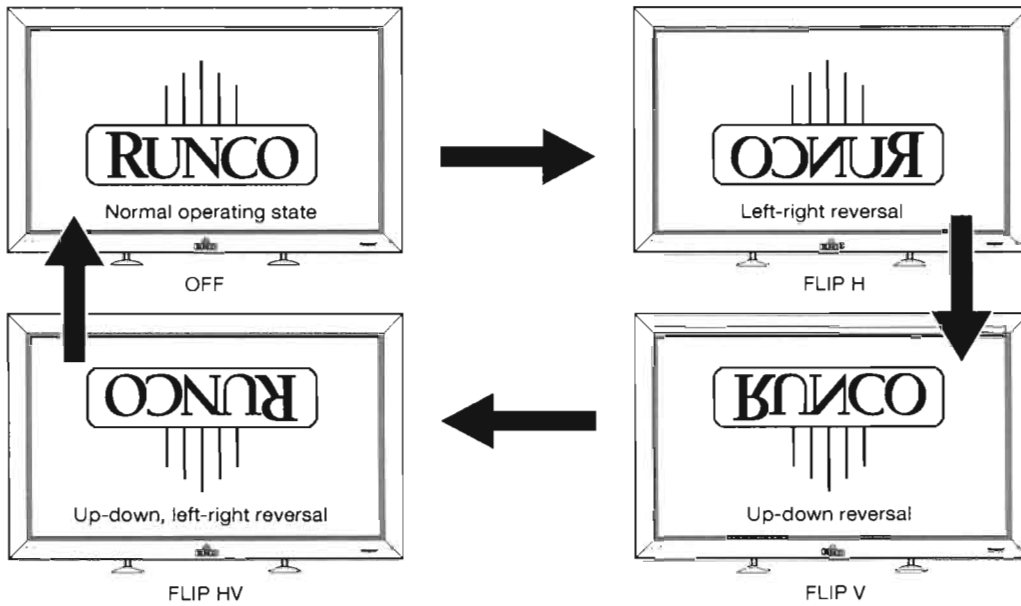

Figure 4-7. Picture Orientation

Function Reset: To restore the CinemaWall to its factory-default state, select **Function Reset** from the Option menu. Then, press ◀ to highlight YES and press **SET**. This action resets ALL settings (except the display ID Number) to their default values, as set at the factory.



Caution

This action is not undoable. Proceed with caution!

4.8 Using Picture-In-Picture (PIP)



Note

PIP is currently supported on Input 1 and Input 2 only.

To use PIP, press the **SPLIT** button.

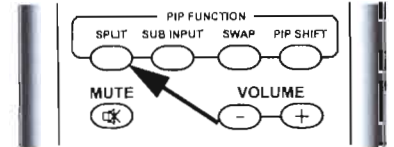

The PIP sub-window appears beside the main image window.

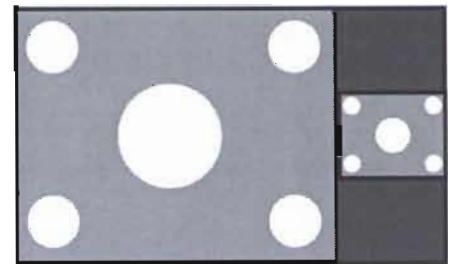

Press **SPLIT** again to display the sub-window superimposed on the main window.

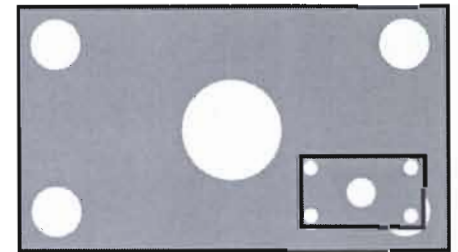

Press **SPLIT** again to turn PIP off.

Selecting a PIP Source ➤

Press the **SUB INPUT** button to select a PIP signal source.

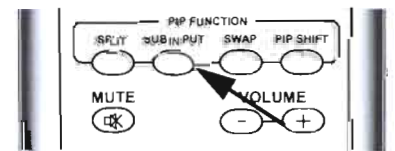

Press the **SWAP** button to replace the main screen with the sub-screen or vice versa. (This switches the audio input as well.)

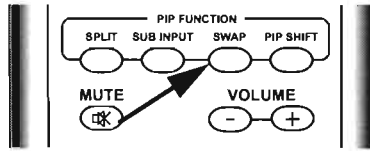

◀ **Swapping the Main and PIP Windows**

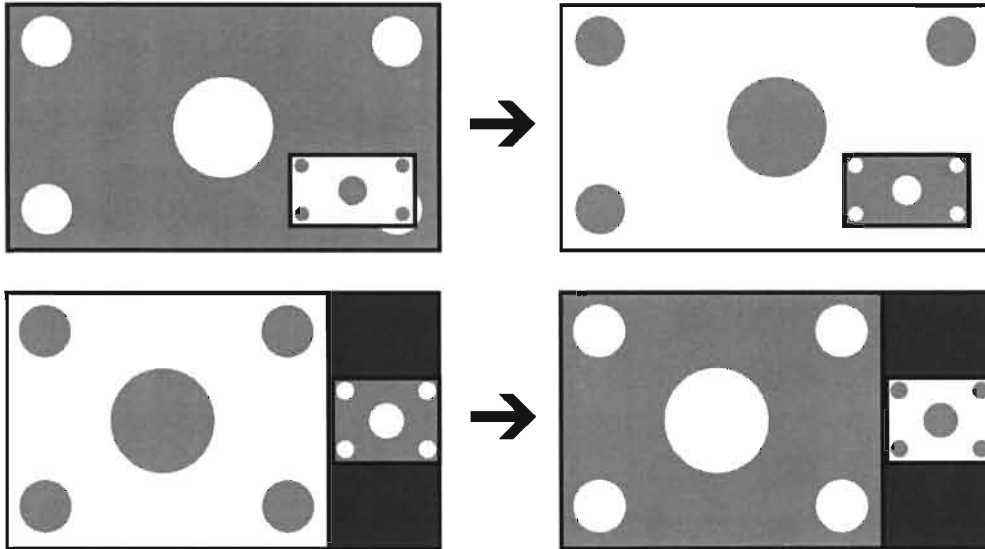

To change the PIP window position, press the **PIP SHIFT** button on the remote control repeatedly until the window is in the desired position.

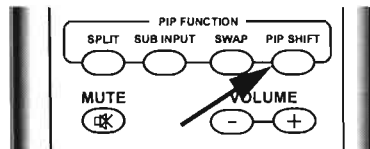

◀ **Changing the PIP Position**

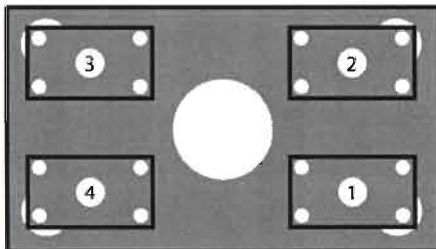

4.9 Enlarging One Part of the Screen

The CinemaWall allows you to zoom in on a portion of the displayed image. To use this feature, press the **MAGNIFY** button repeatedly to select one of four zoom levels (Normal Size, 1.5x, 2x or 3x); see Figure 4-8. When using the zoom feature, a small subscreen appears in the upper-right corner of the display.

Use the directional buttons (▲/▼/◀/▶) to select a magnified image area to display. As you do this, a green plus sign (+) appears in the subscreen to indicate the center of the enlarged area.

Magnification Level 1 (Normal Size)



Magnification Level 3 (2x)



Zoom-Area subscreen

Figure 4-8. Viewing an Enlarged Area of the Display



Note

1. You cannot change the aspect ratio while using the MAGNIFY function.
2. The MAGNIFY function is cancelled if the input signal changes, or if you switch inputs or select PIP mode.

5. Maintenance and Troubleshooting

Regular cleaning will extend the life and performance of the CinemaWall. Before cleaning, be sure to unplug the power cord from the power outlet.

Do not under any circumstances use solvents such as benzene or thinner to clean the CinemaWall. Doing so may cause deterioration or peeling of paint from the display or remote control unit.

Wipe the display and remote control gently with a soft cloth. In the case of excessive dirt buildup, dampen a soft cloth with a diluted neutral cleaning detergent and after wringing the cloth thoroughly, wipe the component and then dry it with a dry soft cloth.

After dusting, wipe the screen gently using the supplied cleaning cloth or another soft cloth (cotton, flannel etc.). Do not use tissue or a rough cloth. The screen surface is easily scratched; do not rub it or hit it with a hard object.

If you clean the surface of the screen with a wet cloth, water droplets on the surface may enter into the product and cause a malfunction.

As a general rule, use a vacuum cleaner about once a month to clean the vents on the rear panel of the display of dust buildup (set the vacuum cleaner to its weakest setting when doing this). If not removed, accumulated dust can cause the internal temperature to increase, resulting in possible breakdown or fire.

Table 5-1 provides some general guidelines for troubleshooting problems you may encounter with the CinemaWall. If the suggested solutions fail to resolve the problem or if you encounter an issue not described here, please contact your Runco dealer or Runco Technical Support.

Table 5-1. Troubleshooting Chart

Symptom	Possible Cause(s)	Solution
The display does not turn on after initial installation.	<ul style="list-style-type: none">The CinemaWall is not plugged in or the AC outlet is not active.The remote control batteries have run out.	<ul style="list-style-type: none">Ensure that the CinemaWall is plugged in and that the AC outlet is active.Replace the batteries.
The display is on, but there is no picture or sound.	<ul style="list-style-type: none">Incorrect source selection.Source component is not turned on.Source component is connected incorrectly or not at all.	<ul style="list-style-type: none">Select the correct source.Turn on the source component.Check video connections to source component.

5.1 Cleaning

◀ Cleaning the Display Panel Body and Remote Control

◀ Cleaning the Screen

◀ Cleaning the Vents

5.2 Troubleshooting Tips

Table 5-1. Troubleshooting Chart (continued)

Symptom	Possible Cause(s)	Solution
Picture is okay, but there is no sound.	<ul style="list-style-type: none"> • Audio output is muted. • Volume setting is too low. • Source component is connected incorrectly or not at all. 	<ul style="list-style-type: none"> • Press the MUTE button on the remote control. • Turn up the volume. • Check audio connections to source component.
Image is too bright and/or lacks definition in the bright areas of the image.	<ul style="list-style-type: none"> • Contrast is set too high. 	<ul style="list-style-type: none"> • Lower the contrast setting.
Image appears “washed out” and/or dark areas appear too bright.	<ul style="list-style-type: none"> • Brightness is set too high. 	<ul style="list-style-type: none"> • Lower the brightness setting.
Colors in the image are swapped; for example, reds appear blue or vice versa.	<ul style="list-style-type: none"> • Incorrect color space setting. • The Pr, Y or Pb outputs from the source to Input 4 on the CinemaWall are incorrect. 	<ul style="list-style-type: none"> • Select the correct color space (refer to Color Space on page 37). • Ensure that the YPbPr (component) source output connections to Input 4 are correct (see Figure 3-7).
RGB-HD images appear “noisy.”	<ul style="list-style-type: none"> • Frequency and Phase settings need adjustment. 	<ul style="list-style-type: none"> • Manually adjust Frequency and Phase settings, or perform an Auto Setup (refer to Screen on page 35).
One of the following error messages appears on-screen: <ul style="list-style-type: none"> • CAUTION OUT OF RANGE • CAUTION UNSUPPORTED SIGNAL • SIGNAL NG 	<ul style="list-style-type: none"> • The resolution and frequency of the video card in the computer are not compatible with the CinemaWall. 	<ul style="list-style-type: none"> • Select a compatible resolution and vertical frequency (refer to Computer/Video Signal Compatibility on page 63).
The image is too large or too small.	<ul style="list-style-type: none"> • Image size needs adjusting. 	<ul style="list-style-type: none"> • Adjust the image size (refer to Screen on page 35).
One of the following error messages appears on-screen: <ul style="list-style-type: none"> • WARNING THERMAL ALERT SHUT DOWN (**) • WARNING FAN FAILURE SHUT DOWN (**) <p>(“(**)” represents a two-digit error code.)</p>	<ul style="list-style-type: none"> • Ambient temperature is too high. • Cooling fan has malfunctioned. 	<ul style="list-style-type: none"> • Turn off main power. Remove any objects blocking the cooling vents on the CinemaWall and/or clean the vents. • Immediately turn off power, remove the power plug from its outlet, and consult your Runco dealer

6. Serial Communications

To interface the CinemaWall with a home theater automation/control system or a PC running terminal emulation software, connect it to your control system or PC as shown in Figure 3-12.

Configure the RS-232 controller or PC serial port as follows: no parity, 8 data bits, 1 stop bit and no flow control. Set the baud rate to 115200, to match that of the CinemaWall RS-232 port.

Serial commands to the CinemaWall take the following form:

- You can send commands in either hexadecimal or ASCII format.
- ASCII commands are not case-sensitive.
- Commands begin with the "Start of Text" (STX) character (02h or <ctrl> B in ASCII), followed by the display ID (2 bytes), the command data and command argument (3 or 6 bytes; refer to Table 6-1) and the "End of Text" (ETX) character (03h or <ctrl> c in ASCII).
- You do not need to send a carriage return after the command.
- The default CinemaWall display ID is 01 (30h 31h). With most commands, you can also use the "wildcard" display ID of "***" (2Ah 2Ah) in place of any value for the ID. However, when requesting status via serial commands, you must use a specific display ID; "***" does not work in these cases.

For example, if the CinemaWall ID number is set to its default value (01 = 30h 31h), send the following sequence to set the contrast to its highest possible level (255):

	STX	ID (2 bytes)	Command (3 bytes)	Argument (3 bytes)	ETX
Hex	02	30 31 or 2A 2A	43 4E 54	32 35 35	03
ASCII	<Ctrl> B	0 1 or * *	C N T	2 5 5	<Ctrl> C

6.1 RS-232 Connection and Port Configuration

6.2 Serial Command Syntax

◀ **Example**

Table 6-1 lists the CinemaWall serial command set. Except where indicated, adjustments made using serial commands are stored in the same memory as those made in Installer Adjust mode.

Table 6-1. Serial Commands

Command		Value Range		Description
ASCII	HEX	Minimum	Maximum	
Power				
POF	50 4F 46	-	-	Power OFF.
PON	50 4F 4E	-	-	Power ON.
Input Select (Note 1)				
IN1	49 4E 31	-	-	Switches the main screen to INPUT1.
IN2	49 4E 32	-	-	Switches the main screen to INPUT2.
IN3	49 4E 33	-	-	Switches the main screen to INPUT3.
IN4	49 4E 34	-	-	Switches the main screen to INPUT4.
IN5	49 4E 35	-	-	Switches the main screen to INPUT5.
INPS01	49 4E 50 53 30 31	-	-	Switches the main screen to INPUT1.
INPS02	49 4E 50 53 30 32	-	-	Switches the main screen to INPUT2.
INPS03	49 4E 50 53 30 33	-	-	Switches the main screen to INPUT3.
INPS04	49 4E 50 53 30 34	-	-	Switches the main screen to INPUT4.
INPS05	49 4E 50 53 30 35	-	-	Switches the main screen to INPUT5.
SSIS01	53 53 49 53 30 31	-	-	Switches the sub screen to INPUT1.
SSIS02	53 53 49 53 30 32	-	-	Switches the sub screen to INPUT2.
SWM	53 57 4D	-	-	Outputs main input to the full screen.
SWS	53 57 53	-	-	Outputs sub input to the full screen.
Aspect Ratio				
AST	41 53 54	-	-	Executes AUTO SETUP on Input 1.
SZMS00	53 5A 4D 53 30 30	-	-	Sets the aspect ratio to PIX by PIX.
SZMS01	53 5A 4D 53 30 31	-	-	Sets the aspect ratio to Standard 4:3.
SZMS02	53 5A 4D 53 30 32	-	-	Sets the aspect ratio to ANAMORPHIC 16:9.
SZMS03	53 5A 4D 53 30 33	-	-	Sets the aspect ratio to LETTERBOX.
SZMS05	53 5A 4D 53 30 35	-	-	Sets the aspect ratio to VIRTUALWIDE.

Notes:

1. When making input-specific adjustments such as to image quality, screen position/size or audio sub-volume, select the input you wish to affect before making such adjustments.
2. These settings are not stored in memory.

Table 6-1. Serial Commands (continued)

Command		Value Range		Description
ASCII	HEX	Minimum	Maximum	
SZMS06	53 5A 4D 53 30 36	–	–	Sets the aspect ratio to 14:9.
SZMS09	53 5A 4D 53 30 39	–	–	Sets the aspect ratio to UNDERSCAN.
SZMS10	53 5A 4D 53 31 30	–	–	Sets the aspect ratio to VIRTUAL CINEMA.
Video				
PMTS00	50 4D 54 53 30 30	–	–	Turns video muting off. (Note 2)
PMTS01	50 4D 54 53 30 31	–	–	Turns video muting on. (Note 2)
STLS00	53 54 4C 53 30 30	–	–	Turns the STILL setting to OFF. (Note 2)
STLS01	53 54 4C 53 30 31	–	–	Turns the STILL setting to ON. (Note 2)
Audio				
AMTS00	41 4D 54 53 30 30	–	–	Turns audio mute OFF. (Note 2)
AMTS01	41 4D 54 53 30 31	–	–	Turns audio mute ON. (Note 2)
AUSS01	41 55 53 53 30 31	–	–	Sets audio source to main.
AUSS02	41 55 53 53 30 32	–	–	Sets audio source to sub.
VOL	56 4F 4C	000	042	Adjusts the audio volume.
Picture-in-Picture (PIP)				
MSCS00	4D 53 43 53 30 30	–	–	Turns 2-screen display operation OFF.
MSSS01	4D 53 53 53 30 31	–	–	Sets PIP sub-screen size to 1 (smallest).
MSSS02	4D 53 53 53 30 32	–	–	Sets PIP sub-screen size to 2.
MSSS03	4D 53 53 53 30 33	–	–	Sets PIP sub-screen size to 3.
MSSS04	4D 53 53 53 30 34	–	–	Sets PIP sub-screen size to 4 (largest).
MSTS01	4D 53 54 53 30 31	–	–	Sets 2-screen operation to 2 SCREEN (side-by-side; main screen on left).
				
Notes:				
1. When making input-specific adjustments such as to image quality, screen position/size or audio sub-volume, select the input you wish to affect before making such adjustments.				
2. These settings are not stored in memory.				

Table 6-1. Serial Commands (continued)

Command		Value Range		Description
ASCII	HEX	Minimum	Maximum	
MSTS02	4D 53 54 53 30 32	-	-	Sets 2-screen operation to PinP (lower right).
MSTS03	4D 53 54 53 30 33	-	-	Sets 2-screen operation to PinP (upper right).
MSTS04	4D 53 54 53 30 34	-	-	Sets 2-screen operation to PinP (upper left).
MSTS05	4D 53 54 53 30 35	-	-	Sets 2-screen operation to PinP (lower left).
MSTS06	4D 53 54 53 30 36	-	-	Sets 2-screen operation to PoutP (side-by-side; small sub-screen on left). 
MSTS08	4D 53 54 53 30 38	-	-	Swaps main and sub-screens in PIP 2-screen mode.
MSTS09	4D 53 54 53 30 39	-	-	Sets 2-screen operation to PoutP (side-by-side; small sub-screen on right). 
MSTS10	4D 53 54 53 31 30	-	-	Sets 2-screen operation to 2 SCREEN (side-by-side, full height; main screen on left). 

Notes:

1. When making input-specific adjustments such as to image quality, screen position/size or audio sub-volume, select the input you wish to affect before making such adjustments.
2. These settings are not stored in memory.

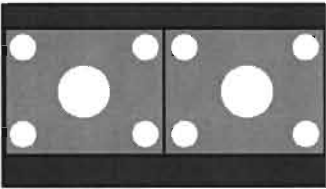
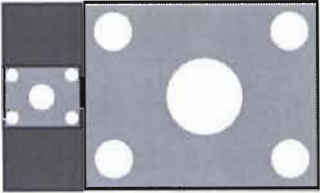
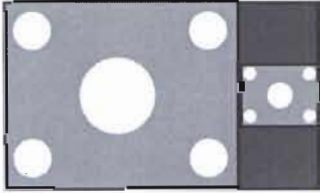
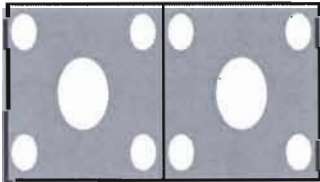
Table 6-1. Serial Commands (continued)

Command		Value Range		Description
ASCII	HEX	Minimum	Maximum	
MSTS11	4D 53 54 53 31 31	–	–	Sets 2-screen operation to 2 SCREEN (side-by-side, full height; main screen on left). 
MSTS12	4D 53 54 53 31 32	–	–	Sets 2-screen operation to 2 SCREEN (side-by-side, full height; main screen on left). 
Functional Lock				
FCLS00	46 43 4C 53 30 30	–	–	Clears the FUNCTIONAL LOCK.
FCLS01	46 43 4C 53 30 31	–	–	Locks the main-control panel button control.
FCLS02	46 43 4C 53 30 32	–	–	Locks the remote-control button control.
FCLS03	46 43 4C 53 30 33	–	–	Locks both main-control panel and remote button control.
FCLS04	46 43 4C 53 30 34	–	–	Sets the MEMORY LOCK.
OSD				
DOF	44 4F 46	–	–	Clears the current displayed OSD. (Note 2)
SET-UP Menu Commands				
CTPS01	43 54 50 53 30 31	–	–	Sets COLOR TEMP. to LOW.
CTPS02	43 54 50 53 30 32	–	–	Sets COLOR TEMP. to MID-LOW.
CTPS03	43 54 50 53 30 33	–	–	Sets COLOR TEMP. to MIDDLE.
CTPS04	43 54 50 53 30 34	–	–	Sets COLOR TEMP. to MID-HIGH.
Notes:				
1. When making input-specific adjustments such as to image quality, screen position/size or audio sub-volume, select the input you wish to affect before making such adjustments.				
2. These settings are not stored in memory.				

Table 6-1. Serial Commands (continued)

Command		Value Range		Description
ASCII	HEX	Minimum	Maximum	
CTPS05	43 54 50 53 30 35	–	–	Sets COLOR TEMP. to HIGH.
CTRS00	43 54 52 53 30 30	–	–	Sets CHROMA EE to OFF.
CTRS01	43 54 52 53 30 31	–	–	Sets CHROMA EE to ON.
DBLS01	44 42 4C 53 30 31	–	–	Sets BLACK LEVEL for INPUT 2 to LOW.
DBLS02	44 42 4C 53 30 32	–	–	Sets BLACK LEVEL for INPUT 2 to HIGH.
DNRS00	44 4E 52 53 30 30	–	–	Sets the VIDEO NR to OFF.
DNRS01	44 4E 52 53 30 31	–	–	Sets the VIDEO NR to LOW.
DNRS02	44 4E 52 53 30 32	–	–	Sets the VIDEO NR to MIDDLE.
DNRS03	44 4E 52 53 30 33	–	–	Sets the VIDEO NR to HIGH.
DSGS01	44 53 47 53 30 31	–	–	Sets PLUG/PLAY setting for INPUT 2 to PC.
DSGS02	44 53 47 53 30 32	–	–	Sets PLUG/PLAY setting for INPUT 2 to VIDEO.
MCDS01	4D 43 44 53 30 31	–	–	Sets COLOR SPACE to RGB (VIDEO).
MCDS02	4D 43 44 53 30 32	–	–	Sets COLOR SPACE to COMPONENT1 (YCbCr).
MCDS03	4D 43 44 53 30 33	–	–	Sets COLOR SPACE to COMPONENT2 (YPbPr).
MNRS00	4D 4E 52 53 30 30	–	–	Turns MPEG FILTER OFF.
MNRS01	4D 4E 52 53 30 31	–	–	Sets MPEG FILTER to LOW.
MNRS02	4D 4E 52 53 30 32	–	–	Sets MPEG FILTER to MIDDLE.
MNRS03	4D 4E 52 53 30 33	–	–	Sets MPEG FILTER to HIGH.
PUCS00	50 55 43 53 30 30	–	–	Turns FILM MODE OFF.
PUCS01	50 55 43 53 30 31	–	–	Turns FILM MODE ON.
SFTS01	53 46 54 53 30 31	–	–	Sets the SIGNAL FORMAT to Type1.
SFTS02	53 46 54 53 30 32	–	–	Sets the SIGNAL FORMAT to Type2.
SFTS03	53 46 54 53 30 33	–	–	Sets the SIGNAL FORMAT to Type3.
SFTS04	53 46 54 53 30 34	–	–	Sets the SIGNAL FORMAT to Type4.
SFTS05	53 46 54 53 30 35	–	–	Sets the SIGNAL FORMAT to Type5.

Notes:

1. When making input-specific adjustments such as to image quality, screen position/size or audio sub-volume, select the input you wish to affect before making such adjustments.

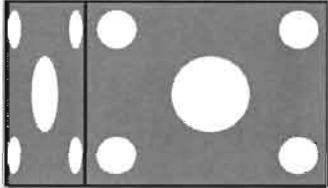
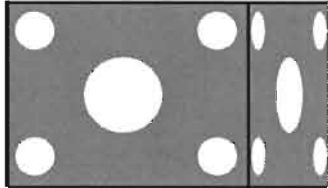
2. These settings are not stored in memory.

Table 6-1. Serial Commands (continued)

Command		Value Range		Description
ASCII	HEX	Minimum	Maximum	
SFTS06	53 46 54 53 30 36	–	–	Sets the SIGNAL FORMAT to Type6.
SFTS07	53 46 54 53 30 37	–	–	Sets the SIGNAL FORMAT to Type7.
SFTS08	53 46 54 53 30 38	–	–	Sets the SIGNAL FORMAT to Type8.
SFTS10	53 46 54 53 31 30	–	–	Sets the SIGNAL FORMAT to Type10.
OPTION Menu Commands				
ESVS00	45 53 56 53 30 30	–	–	Sets the ENERGY MODE setting to AVERAGE.
ESVS01	45 53 56 53 30 31	–	–	Sets the ENERGY MODE setting to LEVEL1 (energy saving).
ESVS02	45 53 56 53 30 32	–	–	Sets the ENERGY MODE setting to LEVEL2 (fixed brightness).
ESVS03	45 53 56 53 30 33	–	–	Sets the ENERGY MODE setting to LEVEL3 (long life).
ESVS04	45 53 56 53 30 34	–	–	Sets the ENERGY MODE setting to AUTO.
ORBS00	4F 52 42 53 30 30	–	–	Turns ORBITER OFF.
ORBS01	4F 52 42 53 30 31	–	–	Sets ORBITER to TYPE 1.
ORBS02	4F 52 42 53 30 32	–	–	Sets ORBITER to TYPE 2.
ORBS03	4F 52 42 53 30 33	–	–	Sets ORBITER to TYPE 3.
SOFS00	53 4F 46 53 30 30	–	–	Turns SOFTEN OFF.
SOFS01	53 4F 46 53 30 31	–	–	Sets SOFTEN to 1.
SOFS02	53 4F 46 53 30 32	–	–	Sets SOFTEN to 2.
SOFS03	53 4F 46 53 30 33	–	–	Sets SOFTEN to 3.
SSTS00	53 53 54 53 30 30	–	–	Sets STILL IMAGE FREEZE to OFF (still image fills screen).
SSTS01	53 53 54 53 30 31	–	–	Sets STILL IMAGE FREEZE to SIDE-BY-SIDE (still image next to moving image).
SSTS02	53 53 54 53 30 32	–	–	Sets STILL IMAGE FREEZE to PinP (still image in sub-screen with moving image).
TPH	54 50 48	000	023	Sets the hour of the present time.

Notes:

1. When making input-specific adjustments such as to image quality, screen position/size or audio sub-volume, select the input you wish to affect before making such adjustments.
2. These settings are not stored in memory.

Table 6-1. Serial Commands (continued)

Command		Value Range		Description
ASCII	HEX	Minimum	Maximum	
TPM	54 50 4D	000	059	Sets the minute of the present time.
TPTS00	54 50 54 53 30 30	–	–	Deactivates program timer.
TPTS01	54 50 54 53 30 31	–	–	Activates program timer.
TPW	54 50 57	001	007	Sets the day of the week of the present time (001 = Sunday ... 007 = Saturday).
TSMS00	54 53 4D 53 30 30	–	–	Sets Daylight Saving Time to OFF.
TSMS01	54 53 4D 53 30 31	–	–	Sets Daylight Saving Time to ON.
PICTURE Menu Commands (Installer Adjust Mode)				
BHI	42 48 49	000	255	Adjusts blue gain (highlight).
BLW	42 4C 57	000	255	Adjusts blue offset (lowlight).
BRT	42 52 54	000	255	Adjusts brightness.
CGB	43 47 42	000	060	Adjusts BLUE color detail.
CGC	43 47 43	000	060	Adjusts CYAN color detail.
CGG	43 47 47	000	060	Adjusts GREEN color detail.
CGM	43 47 4D	000	060	Adjusts MAGENTA color detail.
CGR	43 47 52	000	060	Adjusts RED color detail.
CGY	43 47 59	000	060	Adjusts YELLOW color detail.
CNT	43 4E 54	000	255	Adjusts contrast.
COL	43 4F 4C	000	127	Adjusts color intensity.
ENH	45 4E 48	000	015	Adjusts H. SHARPEN.
ENV	45 4E 56	000	015	Adjusts V. SHARPEN.
GHI	47 48 49	000	255	Adjusts green gain (highlight).
GLW	47 4C 57	000	255	Adjusts green offset (lowlight).
GRAS18	47 52 41 53 31 38	–	–	Sets the GAMMA to 1.8.
GRAS19	47 52 41 53 31 39	–	–	Sets the GAMMA to 1.9.
GRAS20	47 52 41 53 32 30	–	–	Sets the GAMMA to 2.0.
GRAS21	47 52 41 53 32 31	–	–	Sets the GAMMA to 2.1.
GRAS22	47 52 41 53 32 32	–	–	Sets the GAMMA to 2.2.
GRAS23	47 52 41 53 32 33	–	–	Sets the GAMMA to 2.3.

Notes:

1. When making input-specific adjustments such as to image quality, screen position/size or audio sub-volume, select the input you wish to affect before making such adjustments.

2. These settings are not stored in memory.

Table 6-1. Serial Commands (continued)

Command		Value Range		Description
ASCII	HEX	Minimum	Maximum	
GRAS24	47 52 41 53 32 34	–	–	Sets the GAMMA to 2.4.
RHI	52 48 49	000	255	Adjusts red gain (highlight).
RLW	52 4C 57	000	255	Adjusts red offset (lowlight).
SHP	53 48 50	000	015	Adjusts the SHARPNESS.
STD	53 54 44	–	–	Executes FACTORY and WHITE BAL. RESET commands.
TNT	54 4E 54	000	060	Adjusts the TINT.
SCREEN Menu Commands (Installer Adjust Mode)				
CFR	43 46 52	000	255	Adjusts clock (PLL) frequency.
CPH	43 50 48	000	031	Adjusts PLL phase.
FRP	46 52 50	–	–	Executes IMAGE RESET.
HPS	48 50 53	064	191	Adjusts Horizontal position .
HSI	48 49 53	000	064	Adjusts Horizontal size (width).
VPS	56 50 53	064	191	Adjusts the Vertical position.
VSI	56 53 49	000	064	Adjusts Vertical size (height).
SET-UP Menu Commands (Installer Adjust Mode)				
SVL	53 56 4C	000	020	Adjusts the sub-volume.
OPTION Menu Commands (Installer Adjust Mode)				
BPIS01	42 50 49 53 30 31	–	–	Sets BANNER PIP input to INPUT1.
BPIS02	42 50 49 53 30 32	–	–	Sets BANNER PIP input to INPUT2.
BPPS00	42 50 50 53 30 30	–	–	Sets BANNER PIP to OFF.
BPPS01	42 50 50 53 30 31	–	–	Sets BANNER PIP position to TOP.
BPPS02	42 50 50 53 30 32	–	–	Sets BANNER PIP position to MID-HIGH.
BPPS03	42 50 50 53 30 33	–	–	Sets BANNER PIP position to MID-LOW.
BPPS04	42 50 50 53 30 34	–	–	Sets BANNER PIP position to BOT-TOM.
BSL	42 53 4C	000	255	Adjusts BLUE sidebar level.
CLMS00	43 4C 4D 53 30 30	–	–	Sets the ISF SETTING to NORMAL.
Notes:				
1. When making input-specific adjustments such as to image quality, screen position/size or audio sub-volume, select the input you wish to affect before making such adjustments.				
2. These settings are not stored in memory.				

Table 6-1. Serial Commands (continued)

Command		Value Range		Description
ASCII	HEX	Minimum	Maximum	
CLMS01	43 4C 4D 53 30 31	–	–	Sets the ISF SETTING to ISF CCC.
FCA	46 43 41	–	–	Sets FAN SPEED to AUTO.
FDT	46 44 54	–	–	Executes FUNCTION RESET.
FCM	46 43 4D	–	–	Sets FAN SPEED to MAX.
FMKS00	46 4D 4B 53 30 30	–	–	Sets the TEST PATTERN to OFF.
FMKS02	46 4D 4B 53 30 32	–	–	Sets the TEST PATTERN to INVERSE (negative-positive inversion).
FMKS03	46 4D 4B 53 30 33	–	–	Turns ON the WHITE test pattern.
FMKS04	46 4D 4B 53 30 34	–	–	Turns ON the RED test pattern.
FMKS05	46 4D 4B 53 30 35	–	–	Turns ON the GREEN test pattern.
FMKS06	46 4D 4B 53 30 36	–	–	Turns ON the BLUE test pattern.
FMKS07	46 4D 4B 53 30 37	–	–	Turns ON the YELLOW test pattern.
FRCS00	46 52 43 53 30 30	–	–	Sets FRC to SCALER.
FRCS01	46 52 43 53 30 31	–	–	Sets FRC to NORMAL.
GSL	47 53 4C	000	255	Adjusts the GREEN sidebar level.
IDC	49 44 43	–	–	Clears the display ID number (resets to "ALL"); for example, 01IDC.
IDS	49 44 53	–	–	Sets the display ID number; for example, 01IDS sets the display ID to 01h. Note: IDS only works if the display ID number has been cleared (with IDC) or has not been previously assigned.
IPRS01	49 50 52 53 30 31	–	–	Sets the DISPLAY PROFILE to NORMAL.
IPRS02	49 50 52 53 30 32	–	–	Sets the DISPLAY PROFILE to PURE.
IPRS03	49 50 52 53 30 33	–	–	Sets the DISPLAY PROFILE to MONOTONE.
IPRS04	49 50 52 53 30 34	–	–	Sets the DISPLAY PROFILE to HIGH CONTRAST.
LESS00	4C 45 53 53 30 30	–	–	Sets FRONT L.E.D. to OFF.
LESS01	4C 45 53 53 30 31	–	–	Sets FRONT L.E.D. to ON.

Notes:

1. When making input-specific adjustments such as to image quality, screen position/size or audio sub-volume, select the input you wish to affect before making such adjustments.

2. These settings are not stored in memory.

Table 6-1. Serial Commands (continued)

Command		Value Range		Description
ASCII	HEX	Minimum	Maximum	
OSDS00	4F 53 44 53 30 30	–	–	Sets OSD DISPLAY to OFF.
OSDS01	4F 53 44 53 30 31	–	–	Sets OSD DISPLAY to ON.
OSSS01	4F 53 53 53 30 31	–	–	Sets OSD SIZE to LARGE.
OSSS02	4F 53 53 53 30 32	–	–	Sets OSD SIZE to SMALL.
PTRS00	50 54 52 53 30 30	–	–	Sets sub-screen translucence to OFF (0%).
PTRS01	50 54 52 53 30 31	–	–	Sets sub-screen translucence to 10%.
PTRS02	50 54 52 53 30 32	–	–	Sets sub-screen translucence to 20%.
PTRS03	50 54 52 53 30 33	–	–	Sets sub-screen translucence to 30%.
PTRS04	50 54 52 53 30 34	–	–	Sets sub-screen translucence to 40%.
PTRS05	50 54 52 53 30 35	–	–	Sets sub-screen translucence to 50%.
PTRS06	50 54 52 53 30 36	–	–	Sets sub-screen translucence to 60%.
PTRS07	50 54 52 53 30 37	–	–	Sets sub-screen translucence to 70%.
PTRS08	50 54 52 53 30 38	–	–	Sets sub-screen translucence to 80%.
RSL	52 53 4C	000	255	Adjusts the RED sidebar level.
SLSS00	53 4C 53 53 30 30	–	–	Sets SEAMLESS SWITCH to OFF.
SLSS01	53 4C 53 53 30 31	–	–	Sets SEAMLESS SWITCH to ON.
SL1S01	53 4C 31 53 30 31	–	–	Sets SEAMLESS SWITCH SELECT 1 to INPUT 1... INPUT 5.
SL1S02	53 4C 31 53 30 32	–	–	
SL1S03	53 4C 31 53 30 33	–	–	
SL1S04	53 4C 31 53 30 34	–	–	
SL1S05	53 4C 31 53 30 35	–	–	
SL2S01	53 4C 32 53 30 31	–	–	Sets SEAMLESS SWITCH SELECT 2 to INPUT 1... INPUT 5.
SL2S02	53 4C 32 53 30 32	–	–	
SL2S03	53 4C 32 53 30 33	–	–	
SL2S04	53 4C 32 53 30 34	–	–	
SL2S05	53 4C 32 53 30 35	–	–	
USCS00	55 53 43 53 30 30	–	–	Turns the UNDERSCAN setting OFF.
USCS01	55 53 43 53 30 31	–	–	Turns the UNDERSCAN setting ON.

Notes:

1. When making input-specific adjustments such as to image quality, screen position/size or audio sub-volume, select the input you wish to affect before making such adjustments.
2. These settings are not stored in memory.

Table 6-1. Serial Commands (continued)

Command		Value Range		Description
ASCII	HEX	Minimum	Maximum	
Adjustment Commands				
Use these commands in place of a numeric value after a command that requires one, such as the brightness (BRT) command. For example, if the current Brightness setting is 128, you can use either BRTDW0 or BRT118 to reduce the setting by 10.				
DW1	44 57 31	–	–	Reduces adjustment value by n (n = 1 to 9).
DW2	44 57 32			
DW3	44 57 33			
DW4	44 57 34			
DW5	44 57 35			
DW6	44 57 36			
DW7	44 57 37			
DW8	44 57 38			
DW9	44 57 39			
DW0	44 57 30	–	–	Reduces adjustment value by 10.
DWF	44 57 46	–	–	Sets the adjustment value to the minimum value.
UP1	55 50 31	–	–	Adds n to the adjustment value (n = 1 to 9).
UP2	55 50 32			
UP3	55 50 33			
UP4	55 50 34			
UP5	55 50 35			
UP6	55 50 36			
UP7	55 50 37			
UP8	55 50 38			
UP9	55 50 39			
UP0	55 50 30	–	–	Adds 10 to the adjustment value.
UPF	55 50 46	–	–	Sets the adjustment value to maximum.
Notes:				
1 When making input-specific adjustments such as to image quality, screen position/size or audio sub-volume, select the input you wish to affect before making such adjustments.				
2. These settings are not stored in memory.				

7. Specifications

Table 7-1 lists the CinemaWall specifications.

Table 7-1. CinemaWall Specifications

7.1 CinemaWall Specifications

Native Resolution:	1024 x 768
Screen Size (diagonal):	42 in.
Active Screen Area:	36.28 x 20.29 in. (921.6 x 515.3 mm)
Screen Aspect Ratio:	16:9
Available Aspect Ratios:	Standard 4:3, Letterbox, 16:9 Anamorphic, VirtualWide™, Virtual Cinema™, 14:9, Pix-by-Pix (no re-sizing)
DTV Compatibility:	480i/p, 525i/p, 540p, 625i/p, 720p, 1035i, 1080i; 50/60 Hz
ISF Settings:	Yes
Data/Graphics Compatibility:	Refer to Table 7-2
Inputs:	(1) RGB/Component (15-pin D-sub); compatible with Microsoft "Plug & Play" (VESA DDC 1/2B) (1) DVI with HDCP; compatible with Microsoft "Plug & Play" (VESA DDC 2B) (1) Composite Video or S-Video (switch-selectable) (1) HD Component (1) DVI Video with HDCP (5) Audio (stereo mini-jack) (1) RS-232 (9-pin D-sub female)
Outputs:	(1) RGB (15-pin D-sub) (1) Speaker Terminals (stereo pair) (1) Audio (stereo mini-jack); 500 mV RMS / < 5 kΩ
Audio System:	Internal amplifier Output Power = 8W RMS x 2 at 6Ω
Power Requirements:	100 to 240 VAC, 50/60Hz
Power Consumption:	360 Watts (1.5 Watts in standby), maximum
Operating Environment:	40°F to 95°F (5°C to 35°C); 20% to 80% humidity (non-condensing) Altitude = up to 6,000 feet (1,828m)
Dimensions:	See Figure 7-1
Weight (with Stand):	83.0 lbs. (37.65 kg)
Limited Warranty:	Three (3) years parts and labor from the date of delivery to the end user (except for plasma glass panel). Plasma Glass Panel: One (1) year parts and labor from the date of delivery to the end user.

Specifications are subject to change without notice.

7.2 CinemaWall Dimensions

Figure 7-1 shows the CinemaWall dimensions (all dimensions are in inches).

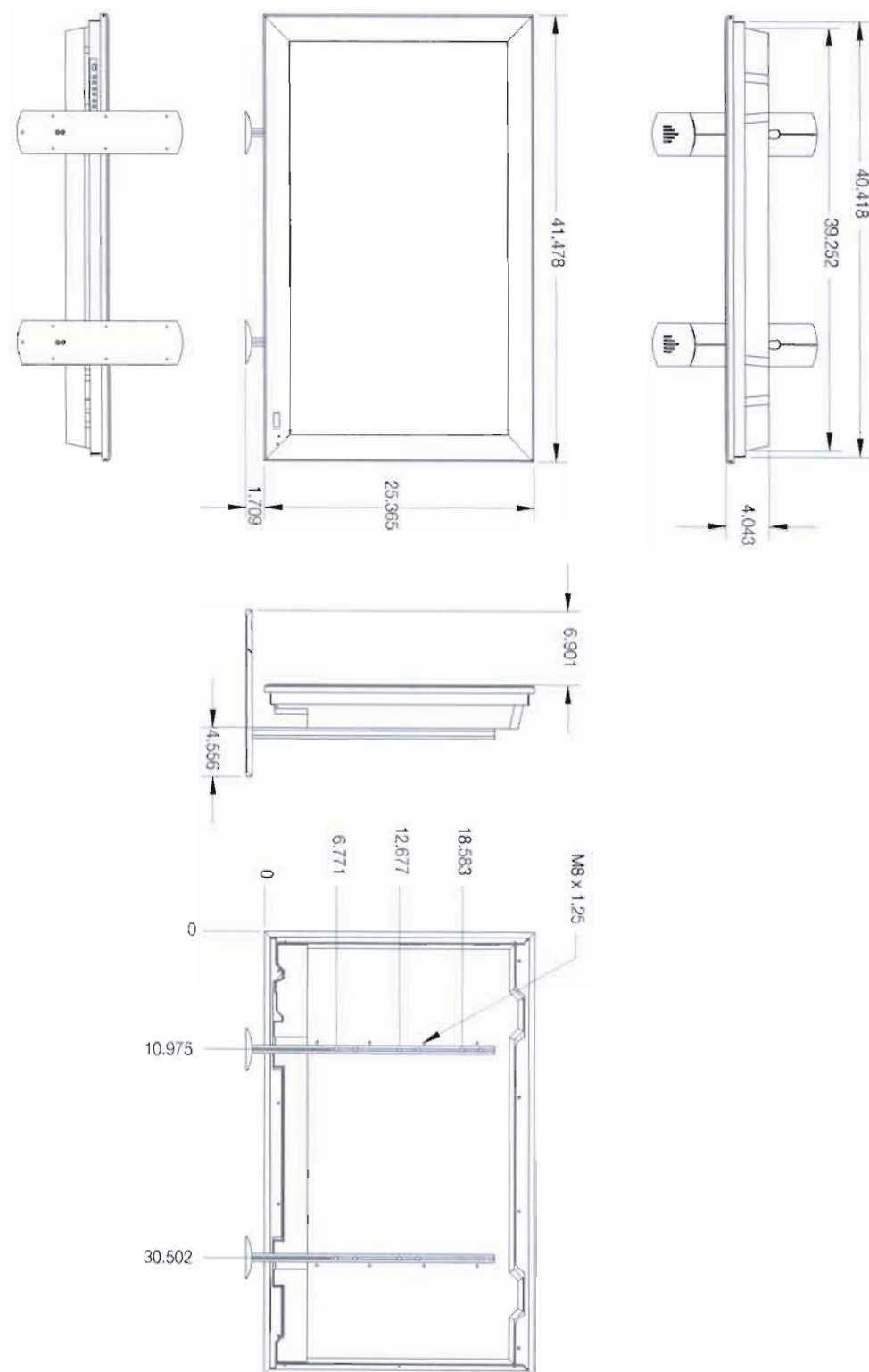

Figure 7-1. CinemaWall Model SP-42 Dimensions (with Optional Table Stand)

The CinemaWall can display video signals from a variety of computer sources via INPUT 1 and INPUT 2.

Table 7-2 lists the signal types that are compatible with the CinemaWall.

Table 7-2. Computer/Video Signal Compatibility Chart

Input Resolution (DotsxLines)	Refresh Rate		INPUT 1	INPUT 2	Remarks
	Vert. (Hz)	Horiz. (kHz)			
640x400	70.1	31.5	√	–	
720x400	70.1	31.5	√	√	
	85.1	37.9	√	√	
640x480	60.0	31.5	√	√	
	66.7	35.0	√	–	Apple® Macintosh® 13"
	72.8	37.9	√	√	
	75.0	37.5	√	√	
	85.0	43.3	√	√	
	100.4	51.1	√	√	I/O DATA
	120.4	61.3	√	√	I/O DATA
848x480	60.0	31.0	√	√	
852x480	60.0	31.7	√	√	I/O DATA
800x600	56.0	35.2	√	√	
	60.0	37.9	√	√	
	72.0	48.1	√	√	
	75.0	46.9	√	√	
	85.0	53.7	√	√	
	99.8	63.0	√	√	I/O DATA
	120.0	75.7	√	√	I/O DATA
832x624	74.6	49.7	√	–	Apple Macintosh 16"
1024x768	60.0	48.4	√	√	
	60.0	49.7	√	√	
	70.0	56.5	√	√	
	75.0	60.0	√	√	
	74.9	60.2	√	–	Apple Macintosh 19"
	85.0	68.7	√	√	
	100.6	80.5	√	√	I/O DATA
	119.4	95.6	√	√	
1152x864	60.0	53.7	√	√	
	72.0	64.9	√	√	
	75.0	67.5	√	√	
1152x870	75.1	68.5	√	–	Apple Macintosh 21"
1152x900	66.0	61.8	√	√	Sun Microsystems LO
	76.0	71.7	√	√	Sun Microsystems HI

7.3 Computer/Video Signal Compatibility

Table 7-2. Computer/Video Signal Compatibility Chart (continued)

Input Resolution (DotsxLines)	Refresh Rate		INPUT 1	INPUT 2	Remarks
	Vert. (Hz)	Horiz. (kHz)			
1280x768	56.0	45.1	√	√	
	60.0	47.8	√	√	
	70.0	56.1	√	√	
1280x800	60.0	49.7	√	√	CVT
1280x854	60.0	53.1	√	√	PC
1280x960	60.0	60.0	√	√	
	85.0	85.9	√	√	
1280x1024	60.0	64.0	√	√	Workstation (SGI)
	60.0	64.6	√	√	Workstation (EWS4800)
	71.2	75.1	√	√	Workstation (EWS4800)
	72.0	78.1	√	√	Workstation (HP)
	75.0	80.0	√	√	
	76.1	81.1	√	√	Workstation (SUN)
	85.0	91.2	√	√	
100.1	108.5	√	-	I/O DATA	
1360x765	60.0	47.7	√	-	
1360x768	60.0	47.7	√	√	I/O DATA
1376x768	59.9	48.3	√	√	I/O DATA
1400x1050	60.0	65.3	√	√	
	74.9	82.3	-	√	
	75.0	82.3	√	-	
	85.0	93.9	√	-	
1440x900	60.0	56.0	√	√	Apple Macintosh 17"
1600x1200	60.0	75.0	√	√	
	65.0	81.3	√	-	
	70.0	87.5	√	-	
	75.0	93.8	√	-	
	85.0	106.3	√	-	
1680x1050	60.0	65.3	√	√	
1920x1200	60.0	74.6	√	-	CVT
1920x1200RB	60.0	74.0	√	√	CVT

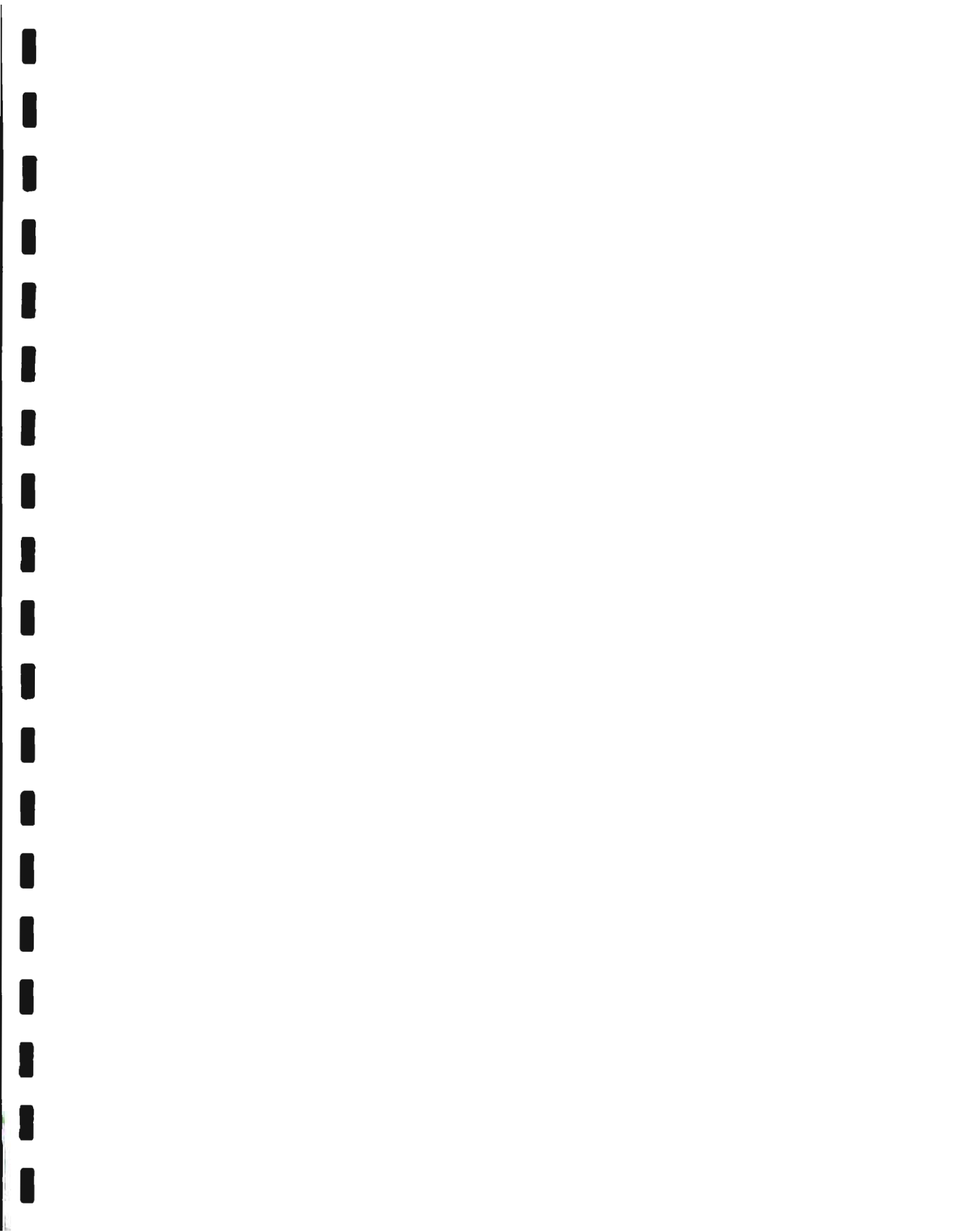

┌ ───────────┐

└ ───────────┘

SERIAL NUMBER
RUMA-011205
rev 09-18-06 v1.1