

# Operator's Manual

## GenSet Model GGDB

with PowerCommand® Control  
PCC1301

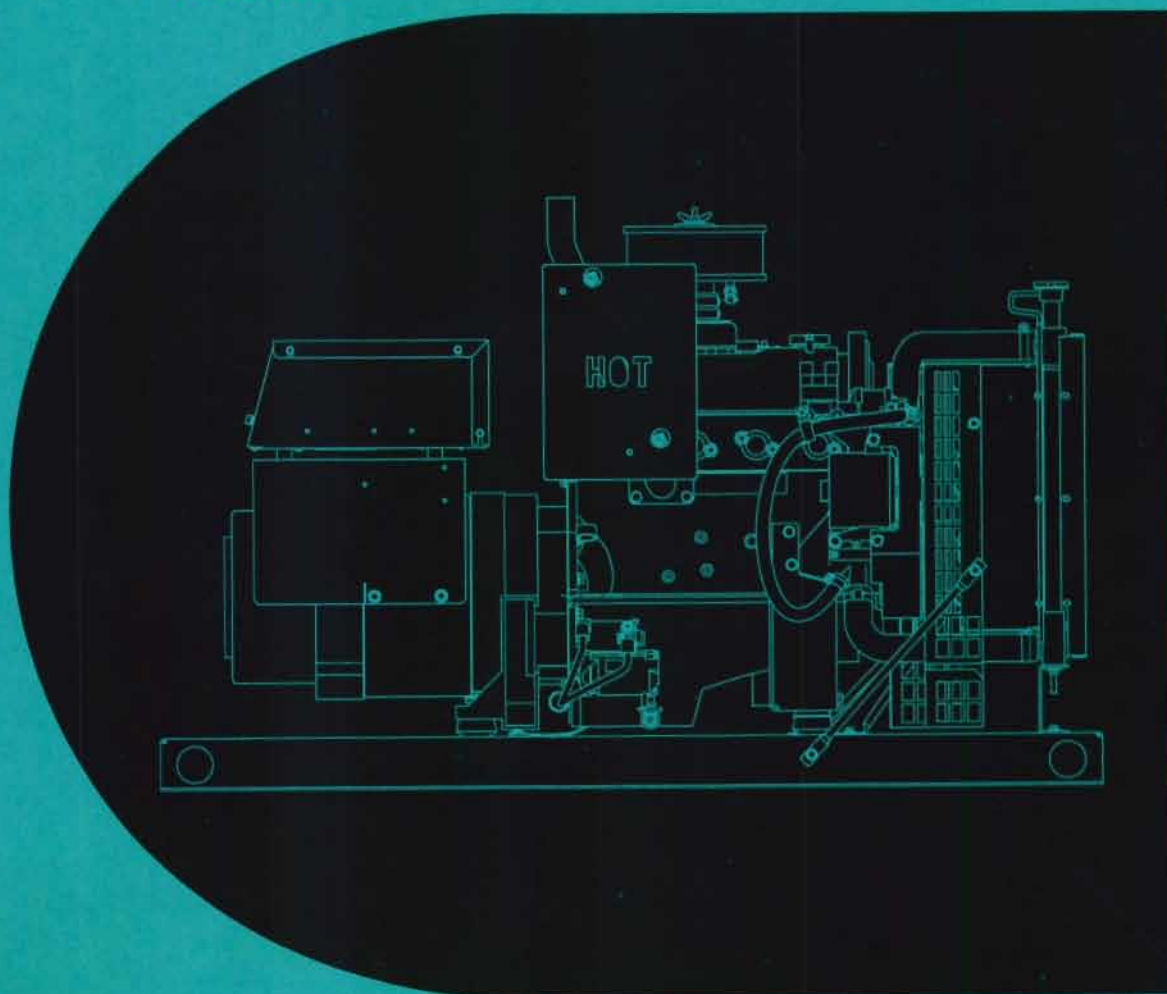

# Table of Contents

---

SECTION	TITLE	PAGE
	<b>IMPORTANT SAFETY INSTRUCTIONS</b> .....	iii
<b>1</b>	<b>INTRODUCTION</b>	
	General .....	1-1
	Generator Set Control .....	1-1
	How to Obtain Service .....	1-2
<b>2</b>	<b>SPECIFICATIONS</b> .....	2-1
<b>3</b>	<b>CONTROL OPERATION (WITHOUT DISPLAY)</b>	
	General .....	3-1
	Prestart Checks .....	3-1
	Control Panel .....	3-2
	Starting .....	3-3
	Stopping .....	3-4
<b>4</b>	<b>CONTROL OPERATION (WITH DISPLAY)</b>	
	General .....	4-1
	Prestart Checks .....	4-1
	Control Panel Power On/Off Modes .....	4-2
	Control Panel .....	4-3
	System Messages .....	4-6
	Starting .....	4-9
	Stopping .....	4-10
	Selecting Auto, Manual Run and Off Modes .....	4-11
	Operating Menus .....	4-14
	Service Menus .....	4-18
	History/About Menu .....	4-20
	Screen Adjust Menu .....	4-22
	Fault History Menu .....	4-24

**▲ WARNING: ▲**  
The engine exhaust from this product contains chemicals known to the State of California to cause cancer, birth defects or other reproductive harm.

<b>SECTION</b>	<b>TITLE</b>	<b>PAGE</b>
<b>5</b>	<b>TROUBLESHOOTING</b>	
	General .....	5-1
	Safety Considerations .....	5-1
	Reading Fault Codes .....	5-2
	Line Circuit Breaker (Optional) .....	5-2
	Control and Diagnostics VIA Network or PC (Laptop) .....	5-2
	Fault Codes .....	5-3
	Fault Code Table .....	5-3
	Troubleshooting Table .....	5-6
<b>6</b>	<b>MAINTENANCE</b>	
	General .....	6-1
	Maintenance Schedule .....	6-2
	Generator Set Inspection .....	6-3
	Generator Set Maintenance (Battery Disconnected) .....	6-4
	Lubrication System .....	6-5
	Cooling System .....	6-7
	Air Filter .....	6-9
	Drive Belt .....	6-9
	Ignition System .....	6-10
	Batteries .....	6-11
	Out-Of-Service Protection .....	6-13
<b>7</b>	<b>ADJUSTMENTS</b>	
	Fuel System Adjustments .....	7-1
<b>8</b>	<b>OPERATING RECOMMENDATIONS</b>	
	Break-In .....	8-1
	No-Load Operation .....	8-1
	Exercise Period .....	8-1
	Low Operating Temperature .....	8-1
	High Operating Temperature .....	8-1

# IMPORTANT SAFETY INSTRUCTIONS

**SAVE THESE INSTRUCTIONS** – This manual contains important instructions that should be followed during installation and maintenance of the generator and batteries.

**Before operating the generator set (genset),** read the Operator's Manual and become familiar with it and the equipment. **Safe and efficient operation can be achieved only if the equipment is properly operated and maintained.** Many accidents are caused by failure to follow fundamental rules and precautions.

The following symbols, found throughout this manual, alert you to potentially dangerous conditions to the operator, service personnel, or the equipment.

**⚠ DANGER** *This symbol warns of immediate hazards which will result in severe personal injury or death.*

**⚠ WARNING** *This symbol refers to a hazard or unsafe practice which can result in severe personal injury or death.*

**⚠ CAUTION** *This symbol refers to a hazard or unsafe practice which can result in personal injury or product or property damage.*

## FUEL AND FUMES ARE FLAMMABLE

Fire, explosion, and personal injury or death can result from improper practices.

- DO NOT fill fuel tanks while engine is running, unless tanks are outside the engine compartment. Fuel contact with hot engine or exhaust is a potential fire hazard.
- DO NOT permit any flame, cigarette, pilot light, spark, arcing equipment, or other ignition source near the generator set or fuel tank.
- Fuel lines must be adequately secured and free of leaks. Fuel connection at the engine should be made with an approved flexible line. Do not use copper piping on flexible lines as copper will become brittle if continuously vibrated or repeatedly bent.
- Natural gas is lighter than air, and will tend to gather under hoods. Propane is heavier than air, and will

tend to gather in sumps or low areas. NFPA code requires all persons handling propane to be trained and qualified.

- Be sure all fuel supplies have a positive shutoff valve.
- Be sure battery area has been well-ventilated prior to servicing near it. Lead-acid batteries emit a highly explosive hydrogen gas that can be ignited by arcing, sparking, smoking, etc.

## EXHAUST GASES ARE DEADLY

- Provide an adequate exhaust system to properly expel discharged gases away from enclosed or sheltered areas and areas where individuals are likely to congregate. Visually and audibly inspect the exhaust daily for leaks per the maintenance schedule. Make sure that exhaust manifolds are secured and not warped. Do not use exhaust gases to heat a compartment.
- Be sure the unit is well ventilated.
- Engine exhaust and some of its constituents are known to the state of California to cause cancer, birth defects, and other reproductive harm.

## MOVING PARTS CAN CAUSE SEVERE PERSONAL INJURY OR DEATH

- Keep your hands, clothing, and jewelry away from moving parts.
- Before starting work on the generator set, disconnect battery charger from its AC source, then disconnect starting batteries, negative (-) cable first. This will prevent accidental starting.
- Make sure that fasteners on the generator set are secure. Tighten supports and clamps, keep guards in position over fans, drive belts, etc.
- Do not wear loose clothing or jewelry in the vicinity of moving parts, or while working on electrical equipment. Loose clothing and jewelry can become caught in moving parts. Jewelry can short out electrical contacts and cause shock or burning.
- If adjustment must be made while the unit is running, use extreme caution around hot manifolds, moving parts, etc.

## **ELECTRICAL SHOCK CAN CAUSE SEVERE PERSONAL INJURY OR DEATH**

- Remove electric power before removing protective shields or touching electrical equipment. Use rubber insulative mats placed on dry wood platforms over floors that are metal or concrete when around electrical equipment. Do not wear damp clothing (particularly wet shoes) or allow skin surface to be damp when handling electrical equipment.
- Use extreme caution when working on electrical components. High voltages can cause injury or death. **DO NOT** tamper with interlocks.
- Follow all applicable state and local electrical codes. Have all electrical installations performed by a qualified licensed electrician. Tag and lock open switches to avoid accidental closure.
- **DO NOT CONNECT GENERATOR SET DIRECTLY TO ANY BUILDING ELECTRICAL SYSTEM.** Hazardous voltages can flow from the generator set into the utility line. This creates a potential for electrocution or property damage. Connect only through an approved isolation switch or an approved paralleling device.

## **GENERAL SAFETY PRECAUTIONS**

- Coolants under pressure have a higher boiling point than water. **DO NOT** open a radiator or heat exchanger pressure cap while the engine is running. Allow the generator set to cool and bleed the system pressure first.
- Benzene and lead, found in some gasoline, have been identified by some state and federal agencies as causing cancer or reproductive toxicity. When checking, draining or adding gasoline, take care not to ingest, breathe the fumes, or contact gasoline.
- Used engine oils have been identified by some state or federal agencies as causing cancer or reproductive toxicity. When checking or changing engine oil, take care not to ingest, breathe the fumes, or contact used oil.
- Keep multi-class ABC fire extinguishers handy. Class A fires involve ordinary combustible materials such as wood and cloth; Class B fires, combustible and flammable liquid fuels and gaseous fuels; Class C fires, live electrical equipment. (ref. NFPA No. 10).
- Make sure that rags are not left on or near the engine.
- Make sure generator set is mounted in a manner to prevent combustible materials from accumulating under the unit.
- Remove all unnecessary grease and oil from the unit. Accumulated grease and oil can cause overheating and engine damage which present a potential fire hazard.
- Keep the generator set and the surrounding area clean and free from obstructions. Remove any debris from the set and keep the floor clean and dry.
- Do not work on this equipment when mentally or physically fatigued, or after consuming any alcohol or drug that makes the operation of equipment unsafe.
- Substances in exhaust gases have been identified by some state or federal agencies as causing cancer or reproductive toxicity. Take care not to breathe or ingest or come into contact with exhaust gases.
- Do not store any flammable liquids, such as fuel, cleaners, oil, etc., near the generator set. A fire or explosion could result.
- Wear hearing protection when going near an operating generator set.
- To prevent serious burns, avoid contact with hot metal parts such as radiator, turbo charger and exhaust system.

**KEEP THIS MANUAL NEAR THE GENSET FOR EASY REFERENCE**

# 1. Introduction

## GENERAL

Each operator should read this manual before operating the generator set (genset) for the first time. A genset must be operated and maintained properly if you are to expect safe and reliable operation. This manual includes a troubleshooting guide and a maintenance schedule.

**WARNING** *Improper operation and maintenance can lead to severe personal injury or loss of life and property by fire, electrocution, mechanical breakdown or exhaust gas asphyxiation. Read Important Safety Instructions pages and carefully observe all instructions and precautions in this manual.*

## GENERATOR SET CONTROL

There are two versions of the PowerCommand® 1301 Control (PCC) that can be configured with this genset. For reference only, they are referred to as PCC 1301 (Without Display) and PCC 1301 (With Display) in this manual (Figure 1-1).

Sections in this manual that are specific to either PCC 1301 control are noted in the section title. All other sections apply to both versions.

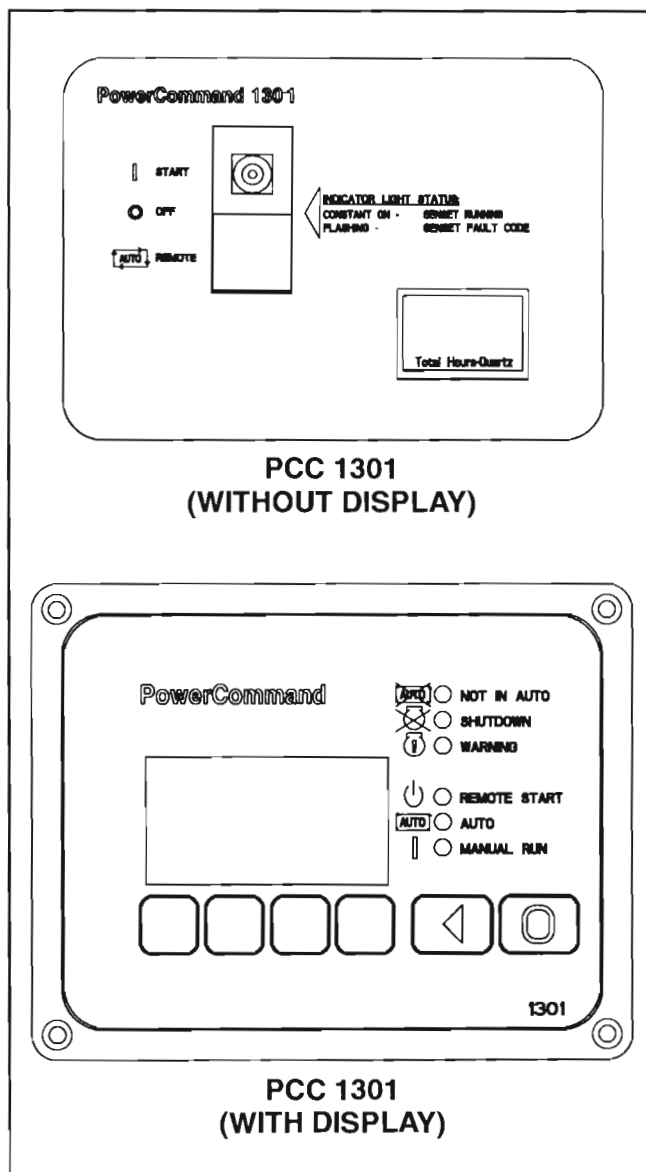

FIGURE 1-1. CONTROL PANEL CONFIGURATIONS

## HOW TO OBTAIN SERVICE

When the generator set requires servicing, contact your nearest Cummins Power Generation distributor. Factory-trained Parts and Service representatives are ready to handle all your service needs.

To contact your local Cummins Power Generation distributor in the United States or Canada, call 1-800-888-6626 (this automated service utilizes touch-tone phones only). By selecting Option 1 (press 1), you will be automatically connected to the distributor nearest you.

If you are unable to contact a distributor using the automated service, consult the Yellow Pages. Typically, our distributors are listed under:

GENERATORS-ELECTRIC or  
ELECTRICAL PRODUCTS

For outside North America, call Cummins Power Generation, 1-763-574-5000, 7:30 AM to 4:00 PM, Central Standard Time, Monday through Friday. Or, send a fax to Cummins Power Generation using the fax number 1-763-528-7229.

When contacting your distributor, always supply the complete Model, Specification, and Serial Number as shown on the generator set nameplate.

### **⚠ WARNING**

***INCORRECT SERVICE OR PARTS REPLACEMENT CAN RESULT IN SEVERE PERSONAL INJURY, DEATH, AND/OR EQUIPMENT DAMAGE. SERVICE PERSONNEL MUST BE TRAINED AND EXPERIENCED TO PERFORM ELECTRICAL AND/OR MECHANICAL SERVICE.***

## 2. Specifications

<b>Engine</b> Onan Modified Ford In-line 4	LRG-4251
<b>Generator kW Rating</b>	See Genset Nameplate for rating information.
<b>Fuel (Single or Dual)</b>	LPG (Vapor or Liquid) Natural Gas LPG (Vapor or Liquid)/Natural Gas
<b>Exhaust</b> Connection Backpressure (Max. Allowed)	1 1/4 inch NPT 41 inch H <sub>2</sub> O
<b>Electrical System</b> Starting Voltage Battery Charging Alternator (Max. Rating)	12 Volts DC 37 amps
<b>Cooling System</b> Capacity with Standard Radiator	3 Gal (11.4 L)
<b>Lubricating System</b> Oil Capacity with Filters	4.5 Qts (4.3 L)
<b>Tune-up Specifications</b> Spark Plug Gap	.032 to .036 (0.8 to 0.9 mm)
<b>Battery</b> Ground Required Battery Voltage Group Number CCA (minimum) Cold Soak @ 0° F (-18° C)	Negative 12 Volts DC 29NF 325
<b>Fuel Supply Pressure</b> LPG/Vapor or Natural Gas Maximum *Minimum LPG/Liquid (**Maximum)	13.6 inches WC (3.4 kPa) 7 inches WC (1.7 kPa) 312 psi (2,153 kPa)
<b>Fuel Consumption (Standby/Full Load/60Hz)</b> LPG (Vapor or Liquid) Natural Gas	84 chf (2.38 m <sup>3</sup> /hr) 252 chf (7.13 m <sup>3</sup> /hr)

\* Minimum pressure refers to supply pressure under rated load (maximum gas flow).

\*\* Under any operating condition.



**THIS PAGE LEFT INTENTIONALLY BLANK**

# 3. Control Operation (Without Display)

## GENERAL

The following describes the function and operation of the PowerCommand® 1301 Control (without display). The switch/indicator and hour meter are located on the face of the control panel as illustrated in Figure 3-1.

This section covers prestart checks, starting and stopping and operating the generator set (genset). Each operator should read through this entire section before they attempt to start the generator set. It is essential that the operator be completely familiar with the generator set and the PCC control. Refer to *Section 8* for operating recommendations.

Before starting, be sure the following checks have been made and the unit is ready for operation.

## PRESTART CHECKS

### Lubrication

Check the engine oil level. Keep the oil level as near as possible to the dipstick high mark without overfilling.

### Coolant

Check the engine coolant level. Refer to "Cooling Systems" in the Maintenance section of this manual for proper procedure.

### Fuel

Make sure the fuel tanks have sufficient fuel and that fuel system is primed. Check to make sure there are no leaks and that all fittings are tight.

### Ventilation

Make sure the generator set cooling inlet/outlet and exhaust ventilation openings are clear (not blocked) and operational.

Remove all loose debris from surrounding area of generator set. Air flow from the radiator fan can blow loose items around and into ventilation openings.

### Exhaust

Check to make sure entire exhaust system is tight, that no combustible materials are near system, and gases are discharged away from building openings.

## EXHAUST GAS IS DEADLY!

***Exhaust gases contain carbon monoxide, an odorless and colorless gas. Carbon monoxide is poisonous and can cause unconsciousness and death. Symptoms of carbon monoxide poisoning can include:***

- ***Dizziness***
- ***Nausea***
- ***Headache***
- ***Weakness and Sleepiness***
- ***Throbbing in Temples***
- ***Muscular Twitching***
- ***Vomiting***
- ***Inability to Think Coherently***

***IF YOU OR ANYONE ELSE EXPERIENCE ANY OF THESE SYMPTOMS, GET OUT INTO THE FRESH AIR IMMEDIATELY. If symptoms persist, seek medical attention. Shut down the unit and do not operate it until it has been inspected and repaired.***

***Protection against carbon monoxide inhalation includes proper installation and regular, frequent visual and audible inspections of the complete exhaust system.***

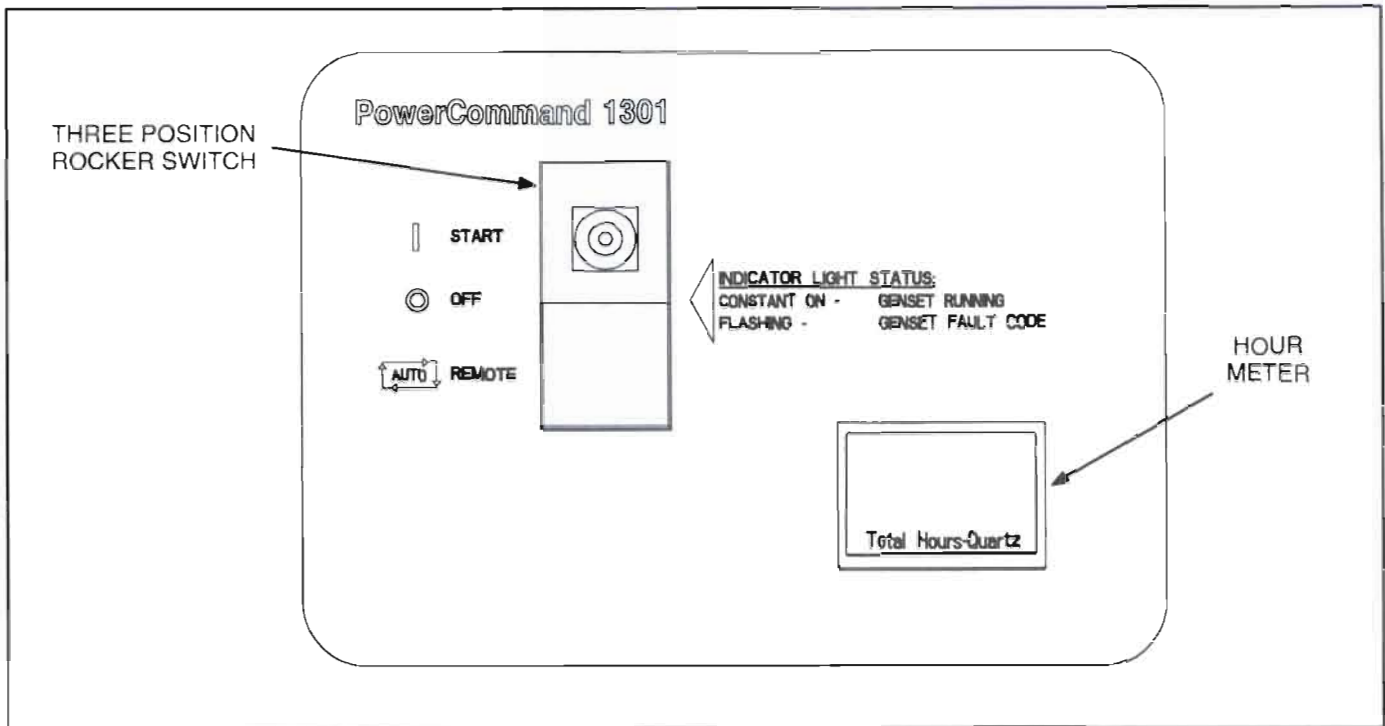

FIGURE 3-1. FRONT PANEL (WITHOUT DISPLAY)

## CONTROL PANEL

Figure 3-1 shows the features of the front panel. It includes one–three position rocker switch to operate the genset and a total hours genset meter.

### Start/Off/Remote (Auto) Switch

This rocker switch is used to select the three operating modes of the genset (Start/Off/Remote). This switch also contains a lamp which is used to indicate engine genset running and genset fault codes.

**OFF Mode:** The OFF mode is enabled by moving the control rocker switch to the middle position. The OFF mode will disable the control Auto or Manual modes.

If moved to the OFF position during generator set operation (manual or remote start), the engine will immediately shut down. If possible, hot shutdown under load should be avoided to help prolong the reliability of the generator set.

The OFF mode is also used to acknowledge shutdown messages after the fault has been corrected. Moving the switch to the OFF position clears the switch fault indication and resets the control.

Refer to *STOPPING* later in this section for a detailed description of the Stop mode.

**REMOTE (Auto) Mode:** The Remote (Auto) mode is enabled by moving the control rocker switch to the bottom position. The Remote mode enables start/stop control of the genset from a remote location.

Refer to *STARTING* and *STOPPING* later this section for a detailed description of the Remote (auto start and stop) mode.

**START Mode:** The Start mode is enabled by moving the control rocker switch to the top position. When moved to this position, the control will activate the starting system. Refer to *STARTING* later this section for a detailed description of the Start mode.

### Switch Indicator

Used to indicate the following genset status:

- Genset running – constant on
- Genset fault code – flashing (refer to *Section 5* to interpret fault code indicator)

### Total Hours Meter

Displays the total hours of genset operation.

## STARTING

The following headings cover the systems used to start the generator set. Figure 3-2 provides a flow chart for remote start/run/stop sequences.

Before starting the generator set, make sure that exhaust and fuel fittings are tight and properly positioned and that proper maintenance has been performed. See *Prestart Checks* in this section.

### Starting at the Control Panel (Start Mode)

Press the control Start switch. This will bypass the Time Delay to Start, activate the engine control system and the starting system. The starter will begin cranking and, after a few seconds, the engine will start and the starter will disconnect.

If the engine does not start, the starter will disengage after a specified period of time and the control will indicate a *Fail To Start* shutdown.

The generator set can be configured for a number of starting cycles (1 to 7 cycles) with set times for crank and rest periods for all starting modes (manual/remote). The default setting is for 3 start cycles, com-

posed of 15 seconds of cranking and 30 seconds of rest.

**The InPower service tool is required to change the cycle number, and the crank and rest times. Contact an authorized service center for assistance.**

To clear a *Fail To Start* shutdown, move the control switch to the OFF position. Before attempting to restart, wait two minutes for the starter motor to cool and then repeat the starting procedure. If the engine does not run after a second attempt, refer to the *Troubleshooting* section.

### Starting from a Remote Location (Remote Mode)

Move the control switch to the Remote position. This allows the generator set to be started from a remote switch or device (e.g., transfer switch).

In response to the Remote Start, the control initiates the starting sequence as shown in Figure 3-2.

When the switch is in the Remote position, the control will utilize the Time Delay To Start function.

**The InPower service tool is required to enable and change the time delay start/stop settings. Contact an authorized service center for assistance.**

## STOPPING

### Before Stopping

Run the generator set at no load for three to five minutes before stopping. This allows the lubricating oil and engine coolant to carry heat away from the combustion chamber and bearings.

### Emergency Stop (Optional)

An emergency stop button (local or remote mounted) is connected to the customer input of the PCC control. This switch, when used, will immediately shutdown the generator set.

To reset, open (disable) emergency stop button and move the control switch to the OFF position.

### Stopping at Control Panel (Manual/Remote Mode)

If the generator set was started at the control panel (Start position) or started remotely (Remote posi-

tion), moving the control switch to the OFF position causes the generator set to stop immediately. If possible, hot shutdown under load should be avoided to help prolong the reliability of the generator set.

### Stopping from Remote Location (Remote Mode)

If the control receives a remote stop signal, the generator set completes its normal shutdown sequence (Figure 3-2). (The remote stop signal is actually the removal of the remote start signal to the control.)

The generator set stops after completing the Time Delay To Stop function (0 to 600 seconds).

The InPower service tool is required to enable and change the time delay start/stop settings. Contact an authorized service center for assistance.

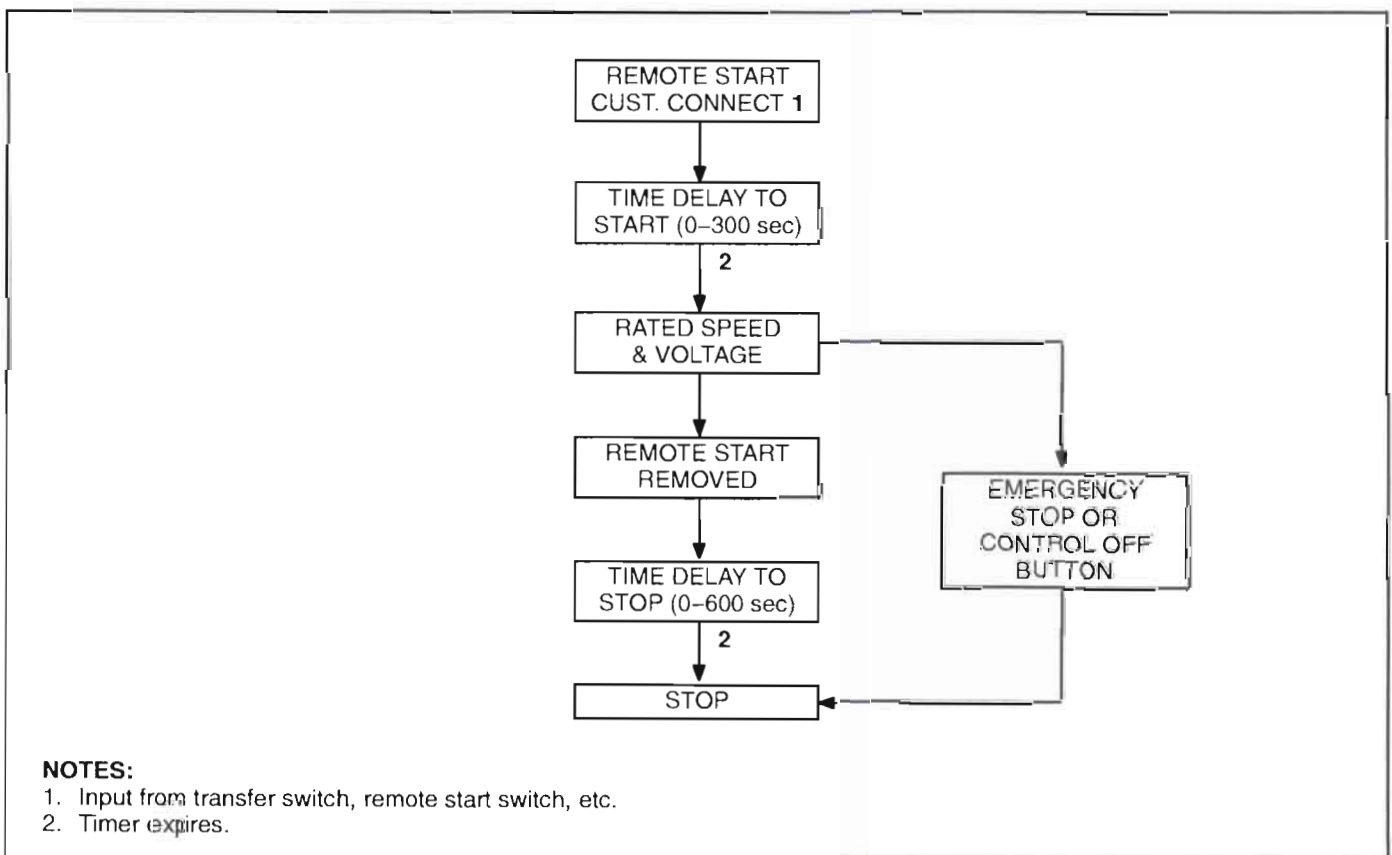

FIGURE 3-2. STARTING WITH CONTROL IN AUTO MODE

# 4. Control Operation (With Display)

---

## GENERAL

The following describes the function and operation of the PowerCommand® 1301 Control (with display). All indicators, control buttons and graphical display are located on the face of the control panel as illustrated in Figure 4-1.

This section covers prestart checks, starting and stopping and operating the generator set (genset). Each operator should read through this entire section before they attempt to start the generator set. It is essential that the operator be completely familiar with the generator set and the PCC control. Refer to *Section 8* for operating recommendations.

Before starting, be sure the following checks have been made and the unit is ready for operation.

## PRESTART CHECKS

### Lubrication

Check the engine oil level. Keep the oil level as near as possible to the dipstick high mark without overfilling.

### Coolant

Check the engine coolant level. Refer to "Cooling Systems" in the Maintenance section of this manual for proper procedure.

### Fuel

Make sure the fuel tanks have sufficient fuel and that fuel system is primed. Check to make sure there are no leaks and that all fittings are tight.

### Ventilation

Make sure the generator set cooling inlet/outlet and exhaust ventilation openings are clear (not blocked) and operational.

Remove all loose debris from surrounding area of generator set. Air flow from the radiator fan can blow loose items around and into ventilation openings.

### Exhaust

Check to make sure entire exhaust system is tight, that no combustible materials are near system, and gases are discharged away from building openings.

## EXHAUST GAS IS DEADLY!

***Exhaust gases contain carbon monoxide, an odorless and colorless gas. Carbon monoxide is poisonous and can cause unconsciousness and death. Symptoms of carbon monoxide poisoning can include:***

- ***Dizziness***
- ***Nausea***
- ***Headache***
- ***Weakness and Sleepiness***
- ***Throbbing in Temples***
- ***Muscular Twitching***
- ***Vomiting***
- ***Inability to Think Coherently***

***IF YOU OR ANYONE ELSE EXPERIENCE ANY OF THESE SYMPTOMS, GET OUT INTO THE FRESH AIR IMMEDIATELY. If symptoms persist, seek medical attention. Shut down the unit and do not operate it until it has been inspected and repaired.***

***Protection against carbon monoxide inhalation includes proper installation and regular, frequent visual and audible inspections of the complete exhaust system.***

## CONTROL PANEL POWER ON/OFF MODES

The power on/off modes of the control panel and operating software are Power On and Sleep.

**Power On Mode:** In this mode, power is continuously supplied to the control panel. The control's operating software and control panel LEDs/graphical display will remain active until the Sleep mode is activated.

**Sleep Mode:** In the Sleep mode, the control's operating software is inactive and the LEDs and the graphical display on the control panel are all off. Sleep mode is a feature used to reduce battery power consumption when the control is not being used and is in either the Off or Auto mode.

When all conditions are met (i.e., no unacknowledged faults and the control is in the Off/Auto mode) the Sleep mode is activated after five minutes of keypad inactivity.

To activate the control and view the menu display without starting the generator set, press any control button.

A qualified service personnel is required to enable or disable the Sleep mode. When shipped from the factory, Sleep mode is enabled for both modes (Off and Auto mode). Internal adjustment of the control also allows the Sleep mode to be active only during the Off mode or disabled for both modes (Off and Auto mode). When disabled, the operating software will always remain active (Power On mode).

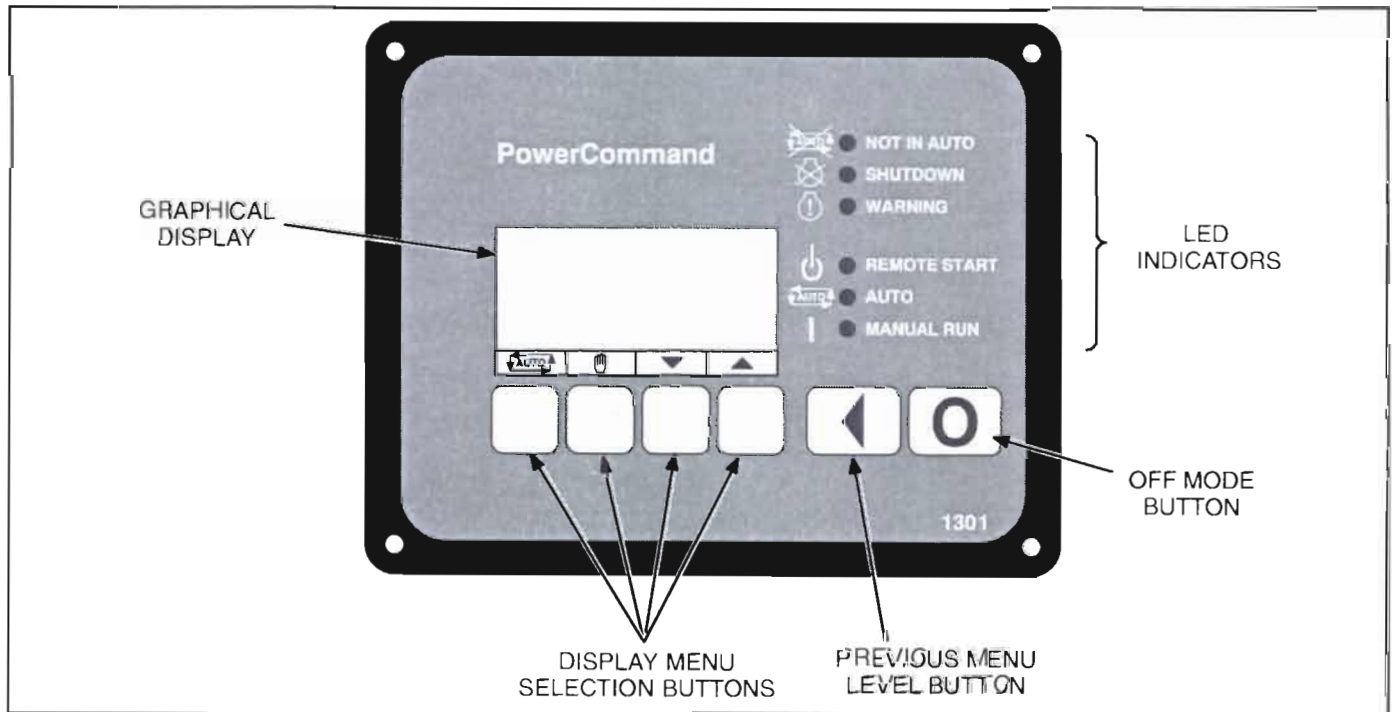

FIGURE 4-1. FRONT PANEL (WITH DISPLAY)

## CONTROL PANEL

Figure 4-1 shows the features of the front panel. It includes six LED indicators, the graphical display, and six buttons used to navigate through the menus and adjust parameters.

### Graphical Display

This graphical display is used to view menus of the menu-driven operating system. The bottom of the graphical display indicates the functions that are available by pressing the four selection buttons. Refer to the menu trees later in this section.













System messages (communication, event, and fault) are also shown on the graphical display. For more information, see *System Messages* later this section.

### Display Text / Symbolic Versions

This graphical display can be set up to show either text or symbolic versions for fault messages, some Operator menus, and the Mode Change menu. A description of commonly used symbols used are included in Table 4-1. Combinations of symbols are used to display some fault conditions. Additional specialized symbols are also used for some faults (see *Section 5*).

A qualified service personnel is required to select text or symbolic display. When shipped from the factory, symbolic display is selected.

TABLE 4-1. SYMBOLS





SYMBOL	DESCRIPTION
	Generator Warning Fault
	Generator Shutdown Fault
	Coolant Temperature
	Oil Pressure
	Voltage Alternating Current (VAC)
	Voltage Direct Current (VDC)
	AC Current
	Frequency
	Battery
	Out of Range
	High or Pre-High
	Low or Pre-Low
	Annunciator







## Display Menu Selection Buttons

Four momentary soft-key buttons are used to step through the various menus and to adjust parameters. These selection buttons are "active" when a word or symbol in the graphical display is shown above the button. Some submenus do not include any active buttons.

The function of the four selection buttons varies with each menu.

- When the  symbol is displayed, the selection button can be used to switch to **Auto** mode.
- When the  symbol is displayed, the selection button can be used to switch to **Manual Run** mode.
- When the up and down triangles ( and ) are displayed, the selection buttons are used to navigate between a series of submenus.

**NOTE:** When any Operator menu (Figure 4-12) is displayed, a series of Service menus can be viewed by simultaneously pressing the  and  selection buttons for two seconds.

**NOTE:** When a fault is displayed, it can be cleared from the front panel by pressing the  or  button.

- When a  symbol is displayed, the selection button can be used to abort the Auto or Manual Run mode and return to the Operator

menu that was displayed before the Auto or Manual Run mode was selected.

- When **ADJUST** is displayed, the selection button is used to display an adjustable menu. When the **ADJUST** button is pressed, the first adjustable parameter or value in the submenu is highlighted.
- When the  symbol is displayed, the selection button is used to navigate to an editable field within a menu.
- When the + and – symbols are displayed, the selection buttons are used to increase or decrease a parameter or value shown on the screen.

When changing values, pressing the button below the + symbol increase the value and pressing the button below the – symbol decreases the value.



- When **SAVE** is displayed, the selection button is used to save changes made in a submenu. **If the Previous Menu button is pressed before pressing SAVE, the changes are not saved.**
- Some menus include a list of numbered subjects. These menus include numbers in parenthesis (for example, (1)) displayed above the selection buttons. The selection buttons are then used to display submenus of the subjects included in the list.
- When a black box  is displayed, the selection button has no function.

## Previous Main Menu Button

Press the  button to view the previous main menu.

**NOTE:** In the Screen Adjust menu, settings are not saved when the  button is pressed.

The  button is also used to acknowledge warning and shutdown messages after the fault has been corrected. Pressing this button clears the fault from the front panel display and the previous menu is redisplayed.

**NOTE:** Pressing the  or  button also clears the fault from the front panel display.

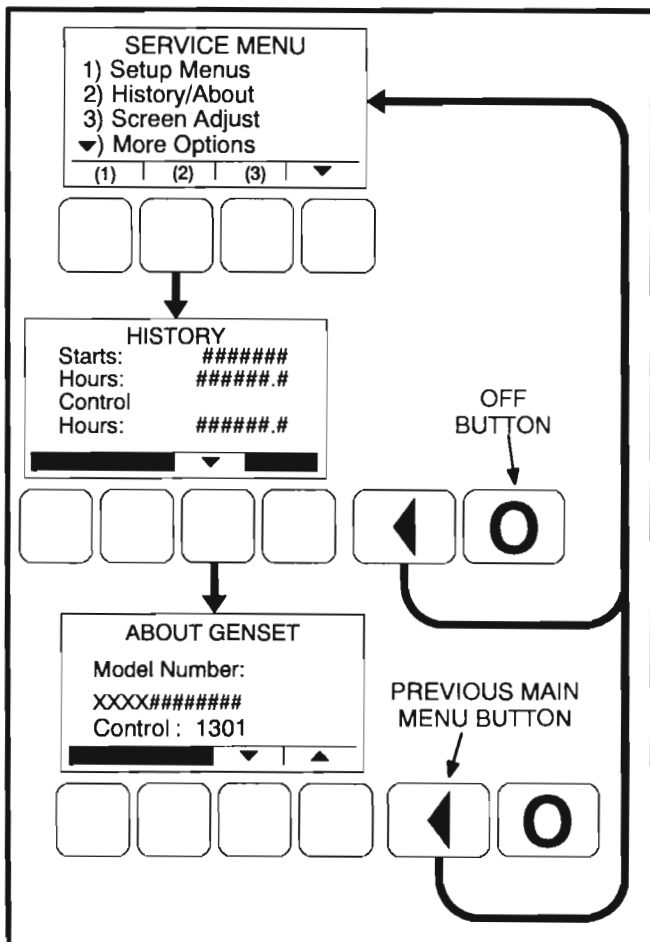

**FIGURE 4-2. PREVIOUS MAIN MENU AND OFF BUTTONS**

## Off Button

Press the  button to switch to the **Off** mode. The Off mode will disable the control Auto or Manual modes.

If the  button is pressed during generator set operation (manual or remote start), the engine will immediately shut down. If possible, hot shutdown under load should be avoided to help prolong the reliability of the generator set.

The  button is also used to acknowledge warning and shutdown messages after the fault has been corrected. Pressing this button clears the fault from the front panel and resets the control.

## Not in Auto Indicator

This red lamp is lit when the control is not in the Auto mode.

## Shutdown Status Indicator

This red lamp is lit when the control detects a Shutdown condition. The generator set cannot be started when this lamp is on. After the condition is corrected, the lamp can be reset by pressing the  (off) button.

## Warning Indicator

This yellow lamp is lit whenever the control detects a warning condition. This lamp is automatically shut off when the warning condition no longer exists.

## Remote Start Indicator

This green lamp indicates the control is receiving a remote run signal.

## Auto Indicator

This green lamp indicates the control is in Auto mode. Auto mode can be selected by pressing the  selection button from any of the Operator menus (see Figure 4-12).

## Manual Run Indicator

This green lamp indicates the control is in the Manual Run mode. Manual Run mode can be selected by pressing the  selection button from any of the Operator menus (see Figure 4-12).

## SYSTEM MESSAGES

A system pop-up message is displayed when the event it is displaying becomes active. These pop-up messages remain displayed until pre-empted by another pop-up message or until the ▼ or the ◀ display buttons is pressed. Once the ▼ or the ◀ button is pressed, the previous screen is redisplayed.

### Communication Messages

System messages are displayed for initial power-up or when there is a subsequent loss of communications. Note that the Auto and Manual Run modes can be selected when communication messages are displayed.

Upon initial power-up, the message “Establishing communication with control” is displayed (see Figure 4-3). This menu also displays the screen’s software number and version.

When the display detects that it is no longer communicating with the control, the Shutdown, Warning, and Remote Start LEDs are turned off.

If communications are lost, the message “Re-establishing communication with control” is displayed until communications have been re-established (see Figure 4-4). The LEDs then return to the state determined by the control.

**If either communication message remains displayed (cannot view other menus), contact an authorized service center for service. This indicates that communications between the control panel and the control logic is lost.**

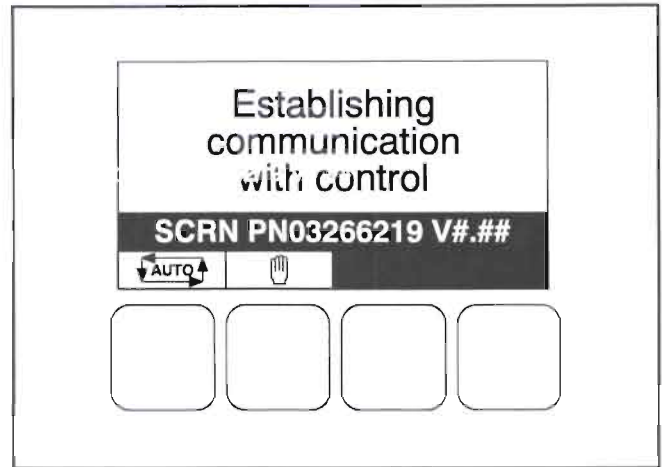

FIGURE 4-3. ESTABLISHING COMMUNICATION WITH CONTROL

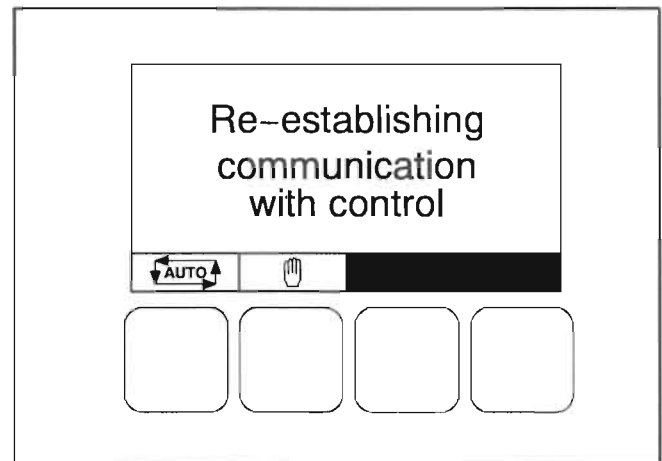

FIGURE 4-4. RE-ESTABLISHING COMMUNICATION WITH CONTROL

## Event Messages

When pre-set events (time delay to start or stop) are activated, Event messages are displayed showing the time remaining until the event occurs (see Figure 4-5).

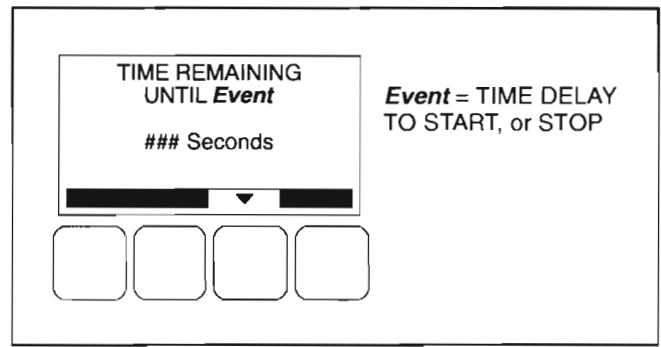

FIGURE 4-5. EVENT MESSAGE

## Fault Messages

A Fault message is an indicator of a Warning or Shutdown condition. It includes the fault number, a short description, and when the fault occurred (see Figure 4-6). Symbolic fault messages include the fault code number and symbols, indicating the type of fault (see Figure 4-7). With the symbolic versions of fault messages, the ⚠ and 🔄 symbols flash. Section 5 provides a list of fault codes, fault types, messages displayed, and descriptions of the faults.

Five of the most recent faults are placed in a fault history file that can be viewed using the Fault History Menu (see Figure 4-18).

## Fault Acknowledgement

Shutdown faults must be acknowledged after the faults have been corrected. If in Auto or Manual Run mode, the control must be set to "O" (off). Also, faults are acknowledged when in Auto and the Remote Start command is removed. Faults are cleared from the control panel display by pressing the ▼, ▲, or ⏏ button.

Faults are re-announced if they are detected again after being acknowledged.

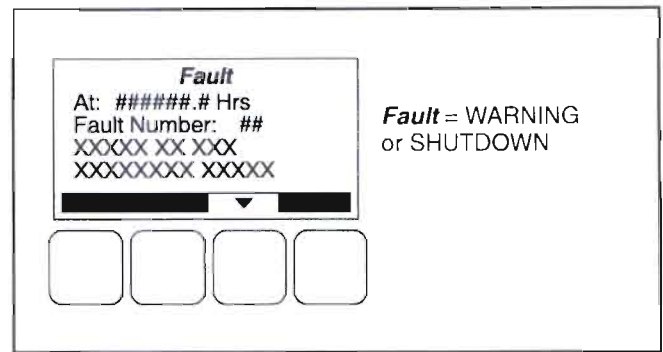

FIGURE 4-6. FAULT MESSAGE

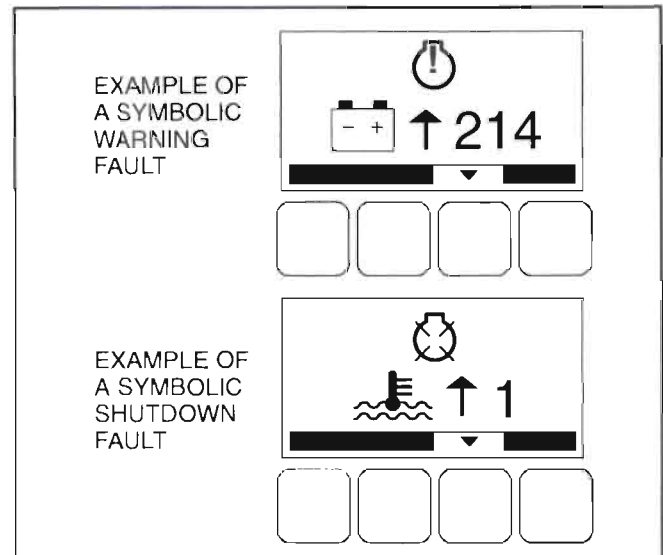



FIGURE 4-7. FAULT MESSAGES – SYMBOLIC VERSION

## STARTING

The following headings cover the systems used to start the generator set. Figure 4-8 provides a flow chart for remote start/run/stop sequences.

Before starting the generator set, make sure that exhaust and fuel fittings are tight and properly positioned and that proper maintenance has been performed. See *Prestart Checks* in this section.

### Starting at the Control Panel (Manual Mode)

Press the  button from any of the Operator menus (see Figure 4-12). This will bypass the Time Delay to Start, activate the engine control system and the starting system. The starter will begin cranking and, after a few seconds, the engine will start and the starter will disconnect.

If the engine does not start, the starter will disengage after a specified period of time and the control will indicate a *Fail To Start* shutdown.

The generator can be configured for 1 to 7 starting cycles with set times for crank and rest periods for all starting modes (manual/remote). The default setting is for 3 start cycles, composed of 15 seconds of cranking and 30 seconds of rest.

**The InPower service tool or access to the Setup menu is required to change the cycle number, and the crank and rest times. Contact an authorized service center for assistance.**

To clear a *Fail To Start* shutdown, press the  (off) button. Before attempting to restart, wait two minutes for the starter motor to cool and then repeat the starting procedure. If the engine does not run after a second attempt, refer to the *Troubleshooting* section.

### Starting from a Remote Location (Auto Mode)

Press the  selection button from any of the Operator menus (see Figure 4-12) This allows the generator set to be started from a remote switch or device (e.g., transfer switch).

In response to the Remote Start, the control lights the Remote Start indicator and initiates the starting sequence as shown in Figure 4-8.

When the switch is in the Auto position, the control will utilize the Time Delay To Start function.

**The InPower service tool or access to the Setup menu is required to enable and change the time delay start/stop settings. Contact an authorized service center for assistance.**

### Cold Starting with Loads

In accordance with NFPA 110, Cummins Power Generation recommends installing diesel standby generator sets (life safety systems) equipped with engine jacket water coolant heaters in locations where the minimum ambient temperature is above 40°F (4°C). NFPA also requires that the engine be heated as necessary to maintain the water jacket temperature determined by the manufacturer for cold start and load acceptance for the type of system. Although most Cummins Power Generation generator sets will start in temperatures down to -25°F (-32°C) when equipped with engine jacket water coolant heaters, it might take more than 10 seconds to warm the engine before a load can be applied when ambient temperatures are below 40°F (4°C).

On generator sets equipped with a graphic display, the **Low Coolant Temperature (Code 203)** message, in conjunction with illumination of the Warning LED, is provided to meet the requirements of NFPA 110. The engine cold sensing logic initiates a warning when the engine jacket water coolant temperature falls below 70°F (21°C). In applications where the ambient temperature falls below 40°F (4°C), a cold engine may be indicated even though the coolant heaters are connected and operating correctly. Under these conditions, although the generator set may start, it may not be able to accept load within 10 seconds. When this condition occurs, check the coolant heaters for proper operation. If the coolant heaters are operating properly, other precautions may be necessary to warm the engine before applying a load.

## STOPPING

### Before Stopping

Run the generator set at no load for three to five minutes before stopping. This allows the lubricating oil and engine coolant to carry heat away from the combustion chamber and bearings.

### Emergency Stop

An emergency stop button (customer supplied) can be connected to the customer input of the PCC control. This switch, when used, will immediately shut down the generator set, light the red Shutdown status indicator and display the emergency stop message (Code 61).

To reset, open (disable) emergency stop button and press the  (Off) button.

### Stopping at Control Panel (Manual/Auto Mode)

If the generator set was started at the control panel (Manual Run indicator is lit) or started remotely

(Auto indicator is lit), pressing the  (Off) button causes the generator set to stop immediately. If possible, hot shutdown under load should be avoided to help prolong the reliability of the generator set.

### Stopping from Remote Location (Auto Mode)

If the control receives a remote stop signal, the generator set completes its normal shutdown sequence (Figure 4-8). (The remote stop signal is actually the removal of the remote start signal to the control.)

The generator set stops after completing the Time Delay To Stop function (0 to 600 seconds).

The InPower service tool or access to the Setup menu is required to enable and change the time delay start/stop settings. Contact an authorized service center for assistance.

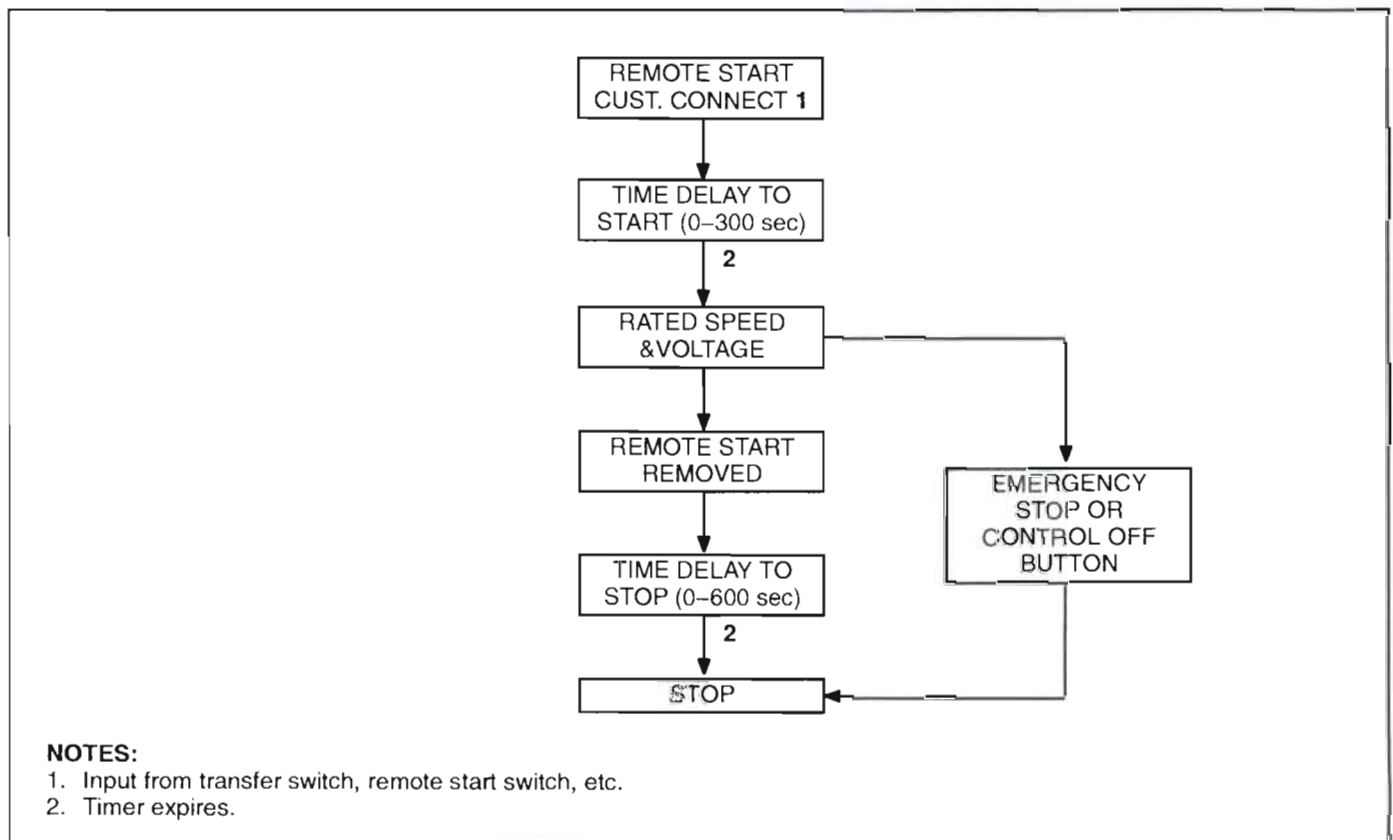

FIGURE 4-8. STARTING WITH CONTROL IN AUTO MODE

## SELECTING AUTO, MANUAL RUN AND OFF MODES

Auto, Manual Run, and Off modes can be selected:

- From any of the Operator menus
- When the message “Establishing communication with control” is displayed
- When the message “Re-establishing communication with control” is displayed

Switching to Auto, Manual Run, or Off mode can be restricted to authorized personnel. If a control panel is set up with the mode change access code feature enabled, an access code must first be entered before the mode can be changed.

**The InPower service tool or access to the Setup menu is required to enable/disable the mode change access code feature. Contact an authorized service center for assistance.**

### Entering the Mode Change Access Code

If the mode change access code feature is enabled, an access code must be entered to switch to Auto, Manual Run, or Off mode. The text and symbolic versions of the Mode Change menu are shown in Figure 4-9.

To enter the mode change access code,

1. With the first character highlighted, press the button below to the + or – symbols until the value reads “1.”
2. Press the arrow selection button → to move to the next numeric character.
3. Press the button below the + or – symbols until the value reads “2.”
4. Press the arrow selection button → to move to the next numeric character.
5. Press the button below the + or – symbols until the value reads “1.”
6. After you have completed entering the password, press the arrow selection button →.

**NOTE:** If an incorrect password is entered, the Operator menu that was displayed before Auto, Manual Run, or Off mode was selected is redisplayed.

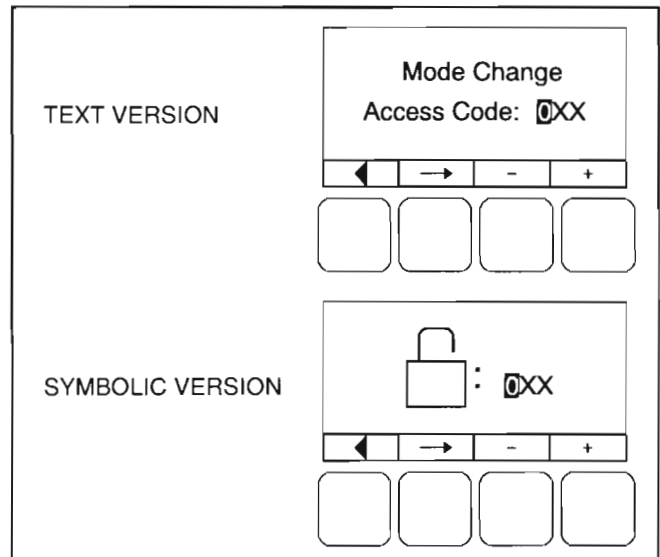





FIGURE 4-9. MODE CHANGE MENU



## Selecting Auto Mode

To switch to Auto mode (see Figure 4-10):

1. Press the  button on any of the Operator menus or the "Establishing/Re-establishing communication with control" menus.
2. If the mode change access code feature is enabled, the Mode Change Access Code menu is displayed. Enter the mode change access code as described above.
3. A menu with alternating arrows is displayed above a second  symbol. Press the second  button. The Operator menu that was displayed before Auto mode was selected is re-displayed and the Auto indicator is lit.
4. To disable auto mode, press the  button.

**NOTE:** Manual Run mode can also be selected while in Auto mode.

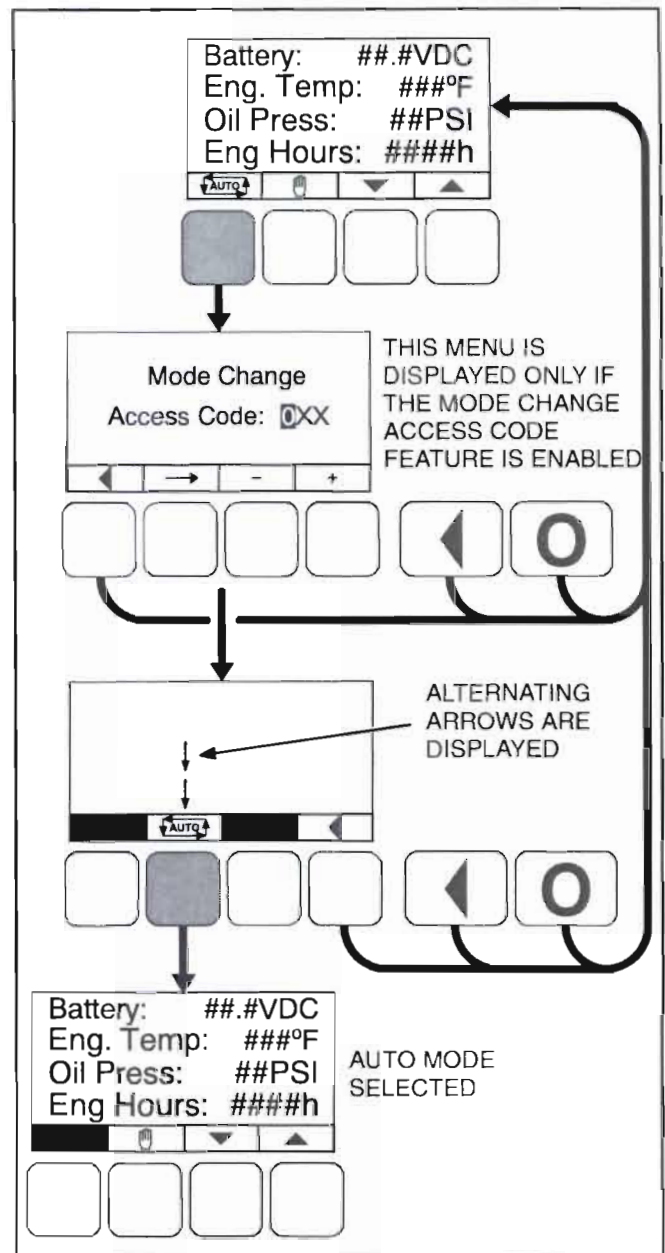





FIGURE 4-10. SELECTING AUTO MODE

## Selecting Manual Run Mode

To switch to Manual Run mode (see Figure 4-11):



1. Press the  button on any of the Operator menus or if displayed, the “Establishing/Re-establishing communication with control” menus.
2. If the mode change access code feature is enabled, the Mode Change Access Code menu is displayed. Enter the mode change access code as described on the previous page.
3. A menu with alternating arrows is displayed above a second  symbol. Press the second  button to start the genset.





The Operator menu that was displayed before Manual Run mode was selected is redisplayed and the Manual Run indicator is lit.

To disable Manual Run mode, press the  button.

**NOTE:** Auto mode can also be selected while in Manual Run mode. Switching to Auto mode may result in the generator set shutting down.

## Aborting the Transition to Auto or Manual Run Mode

If the Mode Change Access Code menu or the menu showing alternating arrows above the  or  buttons is displayed, the transition to Auto or Manual Run mode is aborted when:

- Either the , , or  button is pressed.
- The  or  button is not pressed within ten seconds.

If the transition to Auto or Manual Run mode is aborted, the Operator menu that was displayed before Auto or Manual Run mode was selected is redisplayed.

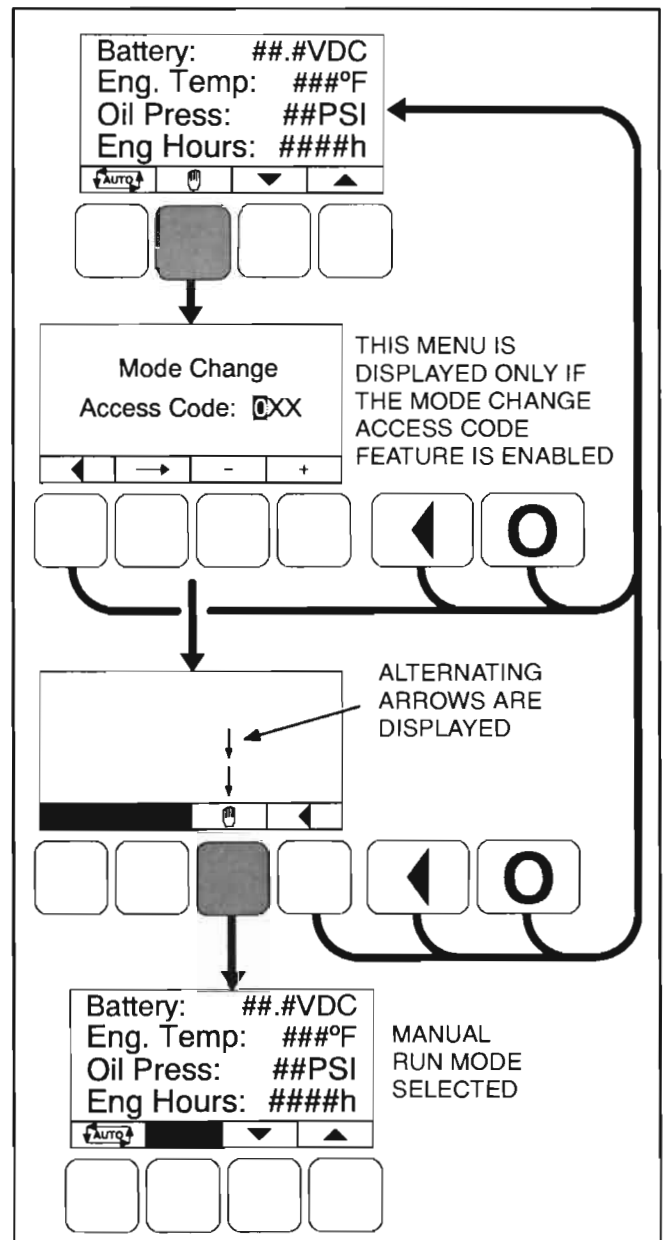

FIGURE 4-11. SELECTING MANUAL RUN MODE

## OPERATOR MENUS

Figures 4-12 and 4-13 show block representations of the following Operator menus.

- Engine Status
- Alternator Status
- Line-to-Line Voltage
- Line-to-Neutral Voltage
- Alternator Amperage

To navigate between the Operator menus, press the buttons next to the ▲ and ▼ symbols in the graphical display.

The Operator menus can be used to select Auto or Manual Run modes.

### Engine Status Menu

This menu displays the engine starting battery voltage, engine coolant temperature, engine oil pressure, and hours of engine operation. (Oil pressure - only available on some models).

### Alternator Status Menu

This menu displays genset power (in kVA), frequency, and engine speed (RPM). (In applications without current transformers, the kVA is not shown.)

### Alternator Line-to-Line Voltage Menu

This menu displays L1-L2, L2-L3, and L3-L1 line-to-line voltages for three phase applications only.

### Alternator Line-to-Neutral Voltage Menu

This menu displays line-to-neutral voltages for L1, L2, and L3 for three phase wye configurations only. (In delta configurations, this menu is not shown.)

### Alternator Single Phase Voltage Menu

This menu displays L1-N, L2-N, and L1-L2 voltages for single phase applications only.

### Alternator Amperage Menu

This menu displays L1, L2, and L3 amperage. (In applications without current transformers, this menu is not shown.)

# OPERATOR MENUS – Text Version

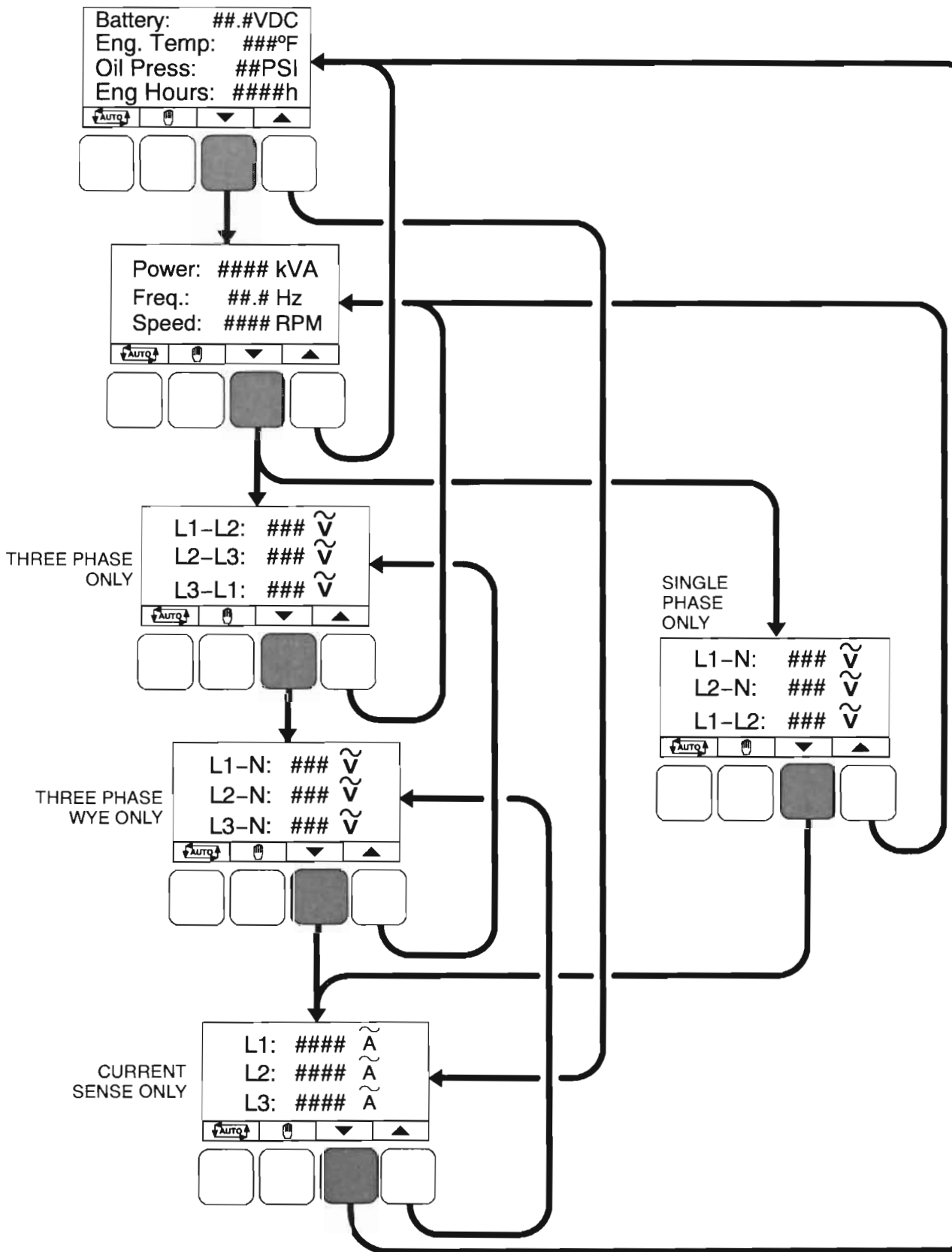

FIGURE 4-12. OPERATOR MENUS (TEXT VERSION)

# OPERATOR MENUS - Symbolic Version

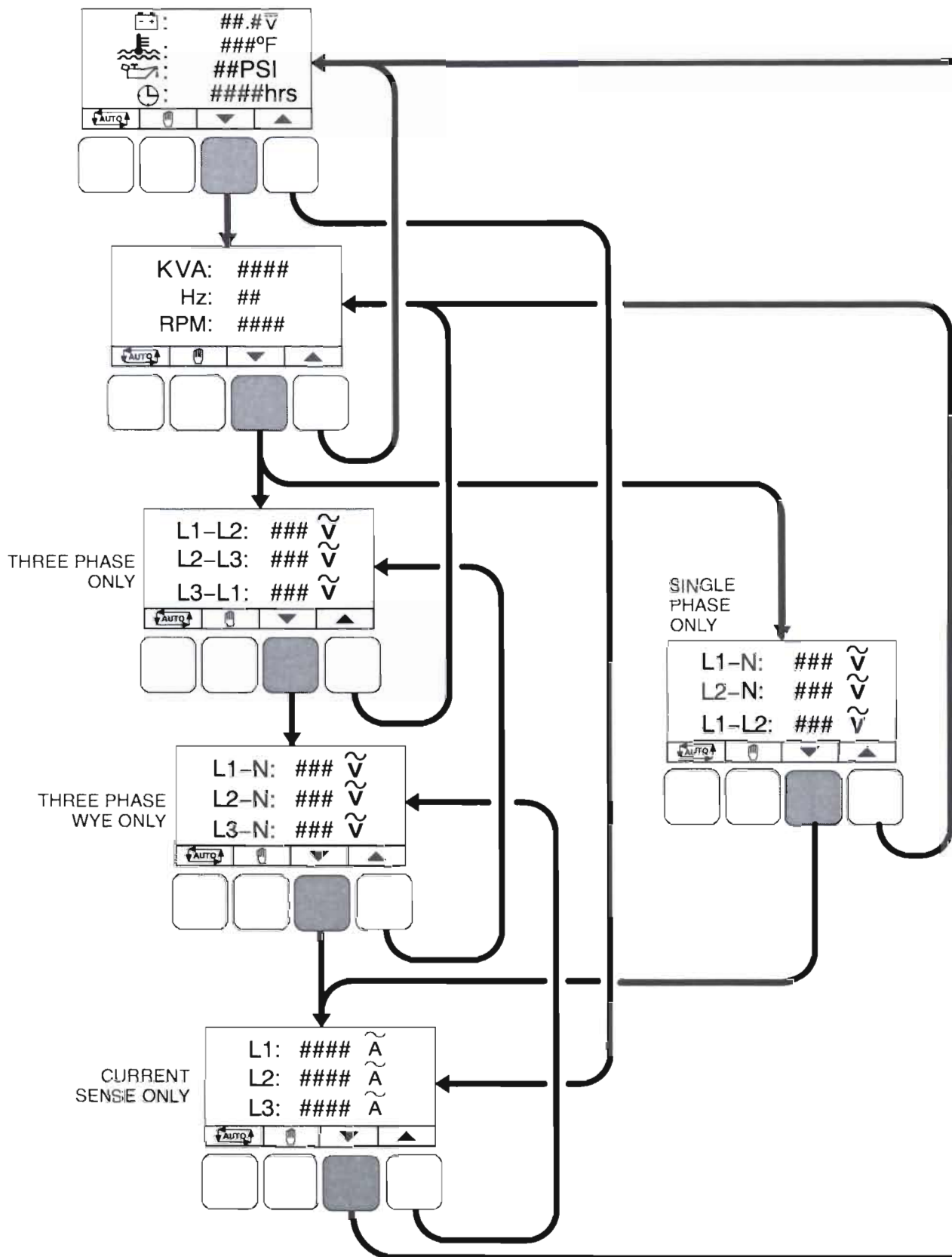

FIGURE 4-13. OPERATOR MENUS (SYMBOLIC VERSION)

**THIS PAGE LEFT INTENTIONALLY BLANK**

## SERVICE MENUS

Figure 4-14 shows a block representation of the menus available from the Service Menus.

The first Service Menu can be viewed from any of the Operator menus by simultaneously pressing the ▲ and ▼ selection buttons for two seconds. The first Service Menu provides access to the following menus:

- Setup Menus – Used by Service personnel. Adjusting the Setup menus is restricted by a password. To view the Setup menus only, press the VIEW button on the Setup password menu.
- History / About – see page 4-20
- Screen Adjust – see page 4-22

To return to the Operator menu that was displayed prior to viewing the Service Menu, press the ◀ button.

The second Service Menu can be viewed by pressing the ▼ selection button on the first Service Menu. The second Service Menu provides access to the following menus:

- Fault History – see page 4-24
- Status – see below
- Lamp Test – The six LEDs on the control panel should light as long as the button (6) is pressed.

The third Service Menu can be viewed by pressing the ▼ selection button on the second Service Menu. The third Service Menu provides access to the Network Status menus.

### Status Menu

The Status menu is displayed when the (5) button is pressed on the second Service Menu. The Status menu shows the following:

- Voltage regulator (drive) level, in percentage of duty cycle
- Governor regulator (drive) level, in percentage of duty cycle. This value is only displayed if the governor is enabled.

### Network Status Menus

The Network Status menus are displayed when the (7) button is pressed on the third Service Menu. Two menus are used to display the quantity of the following devices that are connected to the network.

- Auto Mains Failure (AMF) modules
- Universal Annunciators
- Bar graphs
- Battery chargers
- Controls
- I/O modules
- Operator panels (any type)

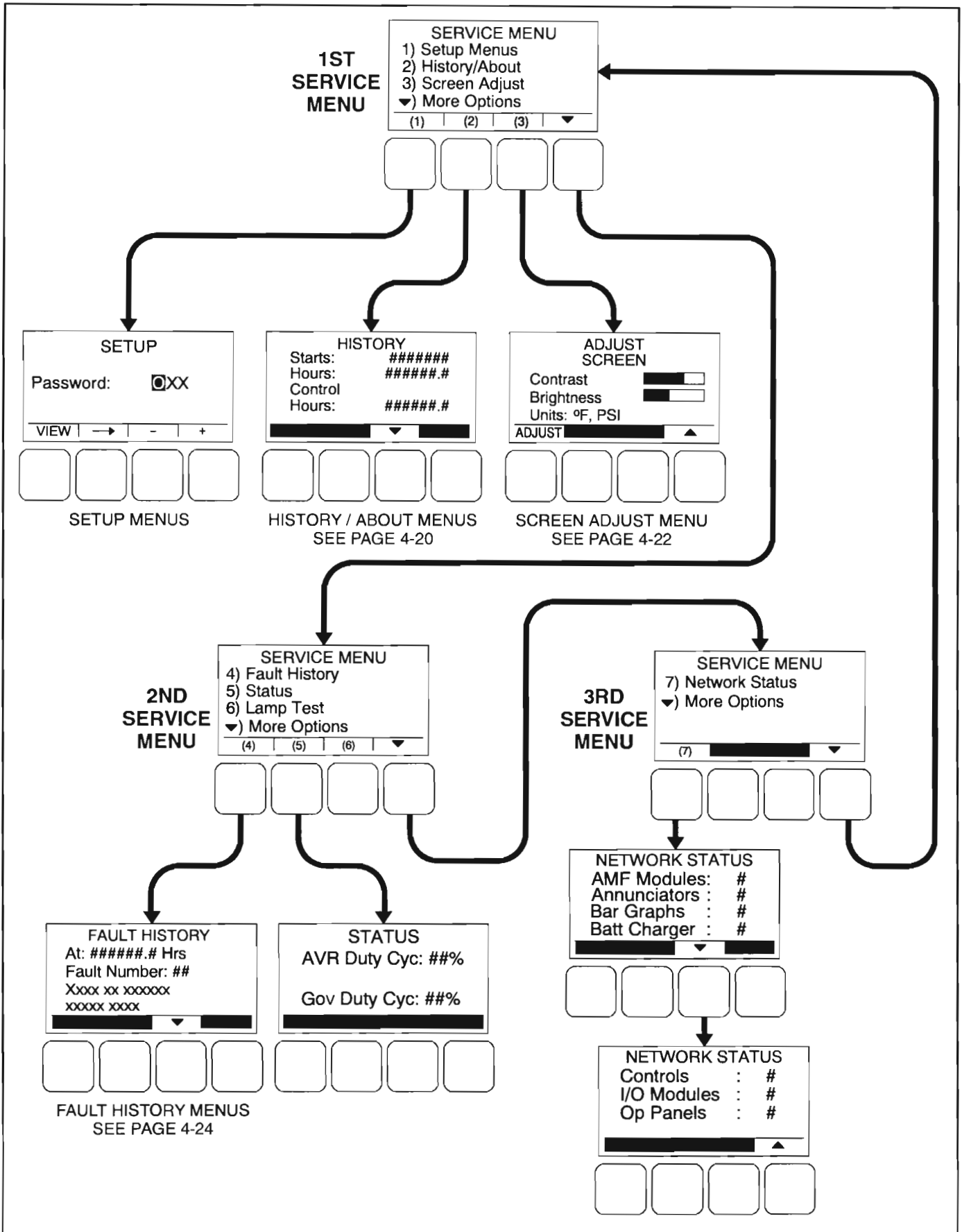

FIGURE 4-14. SERVICE MENUS



## HISTORY / ABOUT MENUS

Figure 4-15 shows a block representation of the History / About menu. The first History / About submenu is displayed when the **(2)** button is pressed on the Service Menu.

Press the buttons next to the ▲ and ▼ symbols in the graphical display to navigate between the History / About submenus. Press the ◀ button to return to the Service Menu.

### History Submenu

This submenu displays the number of engine starts, hours of operation for the engine, and hours of operation for the control.

### About Genset Submenu

This submenu displays the generator set model number and rating.

### About Control Submenu

This submenu displays the control's part number, serial number (up to 11 characters), software part number, and software version.

### About Display Submenu

This submenu displays the optional control panel software part number, software version, screen part number, and screen version of the display.

# HISTORY / ABOUT MENUS

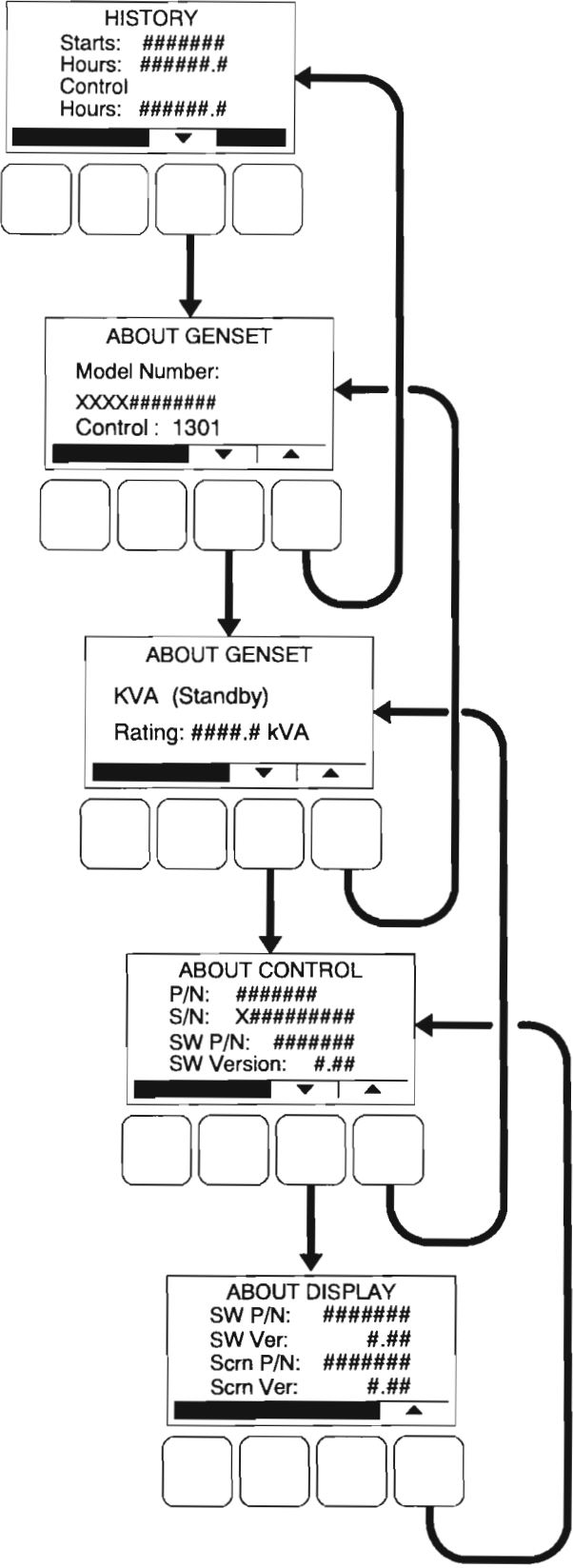

FIGURE 4-15. HISTORY / ABOUT MENUS

## SCREEN ADJUST MENU

Figure 4-16 shows a block representation of the Screen Adjust menu. The Screen Adjust submenu is displayed when the (3) button is pressed in the first Service Menu.

### Adjusting Values/Parameters

1. Press the **ADJUST** selection button to select the first parameter or value to be changed.
2. Press the + or - selection buttons to adjust values or select parameters.
3. Press the arrow selection button → to navigate to the next or previous adjustable value or parameter.
4. After adjusting values/selecting parameters, press the **SAVE** button to save your settings.

**NOTE:** If the Previous Menu button ◀ is pressed before pressing the SAVE button, the changes are not saved.

5. Press the ◀ button to return to the Service Menu.

### Screen Adjust Menu

This menu allows for adjusting the screen's contrast and brightness and for selecting the units of measurement (SAE or SI) to be displayed.

- *Contrast and Brightness:* Press the + or - selection buttons to adjust the screen's contrast and brightness. Changing the brightness setting also affects the brightness of the LEDs on the control panel.
- *Units:* Press the + or - selection buttons to select SAE (°F, PSI) or SI (C, kPa) units of measurement to be displayed.

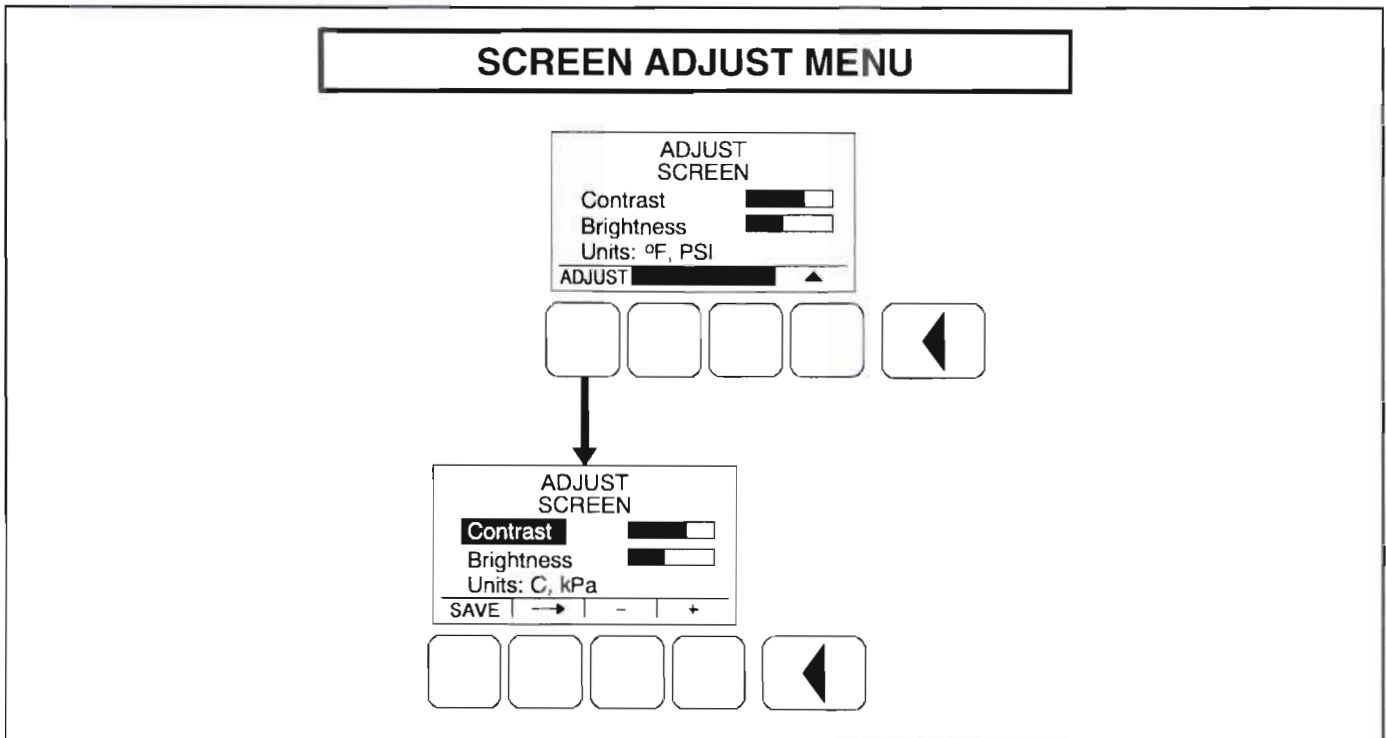

FIGURE 4-16. SCREEN ADJUST MENU

**THIS PAGE LEFT INTENTIONALLY BLANK**

## FAULT HISTORY MENU

Figure 4-18 shows a block representation of the Fault History menu. The first Fault menu is displayed when the **(4)** button is pressed on the second Service Menu. If there are any active fault submenus, an "Active Fault" heading is displayed for the most recent active fault. All other fault submenus display a "Fault History" heading. Five of the most recent faults can be viewed. An example of how a fault code is displayed is shown in Figure 4-17.

Press the buttons next to the ▲ and ▼ symbols in the graphical display to navigate between menus.

Press the ◀ button to return to the Service Menu.

Information on faults is found in *Section 5*.

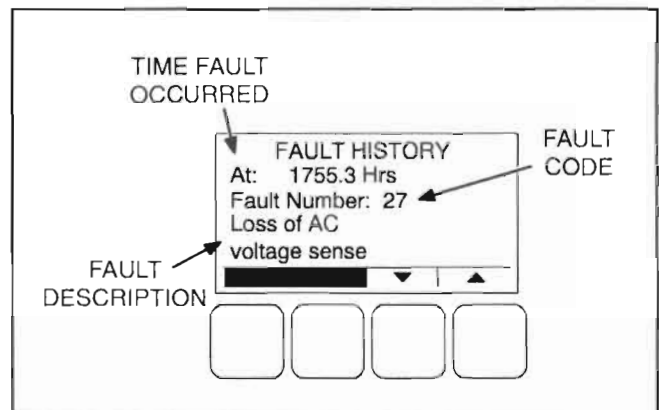

**FIGURE 4-17. FAULT HISTORY MENU EXAMPLE**

**FAULT HISTORY MENU**

**Active Fault**

ACTIVE FAULT  
At: #####.# Hrs  
Fault Number: ##  
Xxxx xx xxxxxx  
xxxx xxxx



**Fault 1**

FAULT HISTORY  
At: #####.# Hrs  
Fault Number: ##  
Xxxx xx xxxxxx  
xxxx xxxx



OR

**Fault 2**

FAULT HISTORY  
At: #####.# Hrs  
Fault Number: ##  
Xxxx xx xxxxxx  
xxxx xxxx



**Oldest Fault  
(Maximum of 5)**

FAULT HISTORY  
At: #####.# Hrs  
Fault Number: ##  
Xxxx xx xxxxxx  
xxxx xxxx



**FIGURE 4-18. FAULT HISTORY MENU**

**THIS PAGE LEFT INTENTIONALLY BLANK**

# 5. Troubleshooting

## GENERAL

The generator set control continuously monitors engine sensors for abnormal conditions when genset is operating, such as low oil pressure and high coolant temperature. If any of these conditions occur, the control (with graphical display) will light a yellow Warning lamp or a red Shutdown lamp and display a message on the graphical display. A control without the graphical display indicates a shutdown condition by intermittent flashing of the status indicator.

This section lists the warning and shutdown codes/messages (Table 5-1), and suggests troubleshooting procedures (Table 5-2).

Displayed error codes that are not listed in Table 5-2 will require an authorized service representative to correct the fault. Contact an authorized service center for assistance.

## SAFETY CONSIDERATIONS

**⚠ WARNING** *Contacting high voltage components can result in severe personal injury or death. Keep the control box and circuit breaker box covers in place during troubleshooting.*

High voltages are present when the generator set is running. Do not open the generator control box or the circuit breaker box while the generator set is running.

**⚠ WARNING** *Ignition of explosive battery gases can cause severe personal injury or death. Arcing at battery terminals, light switch or other equipment, flame, pilot lights and sparks can ignite battery gas. Do not smoke, or switch trouble light ON or OFF near battery. Discharge static electricity from body before touching batteries by first touching a grounded metal surface.*

***Ventilate battery area before working on or near battery—Wear goggles—Stop generator set and disconnect charger before disconnecting battery cables—Disconnect negative (–) cable first and reconnect last.***

**⚠ CAUTION** *Disconnect battery charger from AC source before disconnecting battery cables. Otherwise, disconnecting cables can result in voltage spikes damaging to DC control circuits of the generator set.*

**⚠ WARNING** *Accidental starting of the generator set can cause severe personal injury or death. Prevent accidental starting by disconnecting the negative (–) cable from the battery terminal.*

When troubleshooting a generator set that is shut down, make certain the generator set cannot be accidentally restarted as follows:

1. Without Display: Move the Start/Off/Remote switch on the control panel to the OFF position.

With Display: Press the **⏻** button to switch to the Off mode.

2. Turn off or remove AC power from the battery charger.
3. Remove the negative (–) battery cable from the generator set starting battery.



## READING FAULT CODES

If the genset contains the graphical display and a fault occurs, the fault code/message can be viewed in the display. If the control does not contain the graphical display, the fault code is read from the control switch indicator.

After the fault is acknowledged and corrected, the recorded fault will be deleted from the control panel memory, but will remain in a data log to maintain a fault code history. The InPower service tool is required to view this data log.

**Reading Fault Codes Using Graphical Display:** Refer to *Fault History Menu* in *Section 4*, which describes how to view fault codes using the graphical display.

**Reading Fault Codes Using Control Switch Indicator (PCC without display):** The control panel rocker switch contains a status indicator lamp. This lamp is used to flash genset status and shutdown fault codes. (Only the last shutdown fault code is flashed.) The following describes how to interpret the status indicator light.

**Do not move the control switch to the OFF position before interpreting the fault code. Moving the switch to OFF will clear the fault indication.**

- Constant Fast Flashing = Genset starting.
- Constant On = Genset running.

- Intermittent Flashing = A genset *Shutdown* fault condition exists (*Warning* conditions are not displayed). All of the Shutdown faults described in Table 5-1 can be announced with the status indicator lamp.

An example of a **single digit** fault code – Two blinks, followed by a two-second pause indicates a fault code of “2”.

An example of a **two digit** fault code – first digit in the code is flashed, followed by a half-second pause, and then the second digit is flashed, followed by a two-second pause.

## LINE CIRCUIT BREAKER (OPTIONAL)

Optional line circuit breaker/box mounts to the side of the control saddle bracket. If the load exceeds the circuit breaker current rating, the line circuit breaker will open, preventing the generator from being overloaded. If the circuit breaker trips, locate the source of the overload and correct as necessary. Manually reset the breaker to reconnect the load to the generator.

## CONTROL AND DIAGNOSTICS VIA NETWORK OR PERSONAL COMPUTER (LAPTOP)

See your authorized Cummins Power Generation dealer regarding software, hardware and network requirements for control and diagnostics via network or personal computer.

## FAULT CODES

The fault codes have been divided into four categories to help you determine what corrective action to take for safe operation of the generator set. Use Table 5-1 to find the category (CTG) and fault description for all codes. **Gaps in the code numbers are for codes that do not apply to this genset model. Also, some of the codes listed are feature dependent, and will not be displayed by this genset control.**

**Category A Fault Codes:** Pertain to engine or alternator shutdown faults that require immediate repair by qualified service personnel (generator set non-operational). Control prevents the generator set from being restarted if shutdown fault is not corrected.

**Category B Fault Codes:** Consist of faults that can affect generator set performance or can cause **engine, alternator, or connected equipment damage**. Operate genset only when it is powering critical loads and cannot be shut down. Requires repair by qualified service personnel.

**Category C Fault Codes:** Consist of faults that are repairable by site personnel. Service will be required by qualified service personnel if site personnel cannot resolve the problem after taking the corrective actions suggested in Table 5-2.

**Category D Fault Codes:** Indicates non-critical operational status of generator set, external faults, or customer fault inputs. May require repair by qualified service personnel.

TABLE 5-1. FAULT CODES









CTG	CODE	LAMP	DISPLAYED MESSAGE/SYMBOLS		DESCRIPTION
			TEXT VERSION	SYMBOLIC VERSION	
C	1	Shutdown	HIGH COOLANT TEMP	 1	Indicates that the engine coolant temperature is above normal and has reached the shutdown trip point.
A	2	Shutdown	LOW OIL PRESSURE	 2	Indicates the engine oil pressure has dropped below normal and has reached the shutdown trip point.
A	12	Shutdown	HIGH AC VOLTAGE	 12	Indicates that the one or more measured AC output voltages has exceeded the threshold for longer than a specified time limit. The threshold and time limits are 130% of nominal for 0 seconds or 110% of nominal for 10 seconds.
A	13	Shutdown	LOW AC VOLTAGE	 13	Indicates that the measured AC output voltage is below the threshold for longer than a specified time limit. The threshold and time limits are 85% of nominal for 10 seconds.
A	14	Shutdown	OVER FREQUENCY	 14	Indicates that the alternator frequency is 6 hertz above the governor reference.
C	15	Shutdown	UNDER FREQUENCY	 15	Indicates that the alternator frequency is 6 hertz under the governor reference.
A	27	Shutdown	EXCITATION FAULT	 27	Indicates that a loss of voltage or frequency sensing from the generator has occurred.
A	31	Shutdown	OVERSPEED	 31	Indicates that the engine has exceeded normal operating speed. The default thresholds are 1725 RPM (50 Hz) or 2075 RPM (60 Hz).
A	38	Shutdown	FIELD OVERLOAD	 38	Indicates that the Field AVR Duty Cycle has been at the maximum continuously for 15 seconds.

TABLE 5-1. FAULT CODES (CONT.)



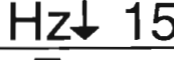









CTG	CODE	LAMP	DISPLAYED MESSAGE/SYMBOLS		DESCRIPTION
			TEXT VERSION	SYMBOLIC VERSION	
A	45	Shutdown	SPEED SIGNAL LOST	 45	Indicates that no magnetic pickup pulses were sensed for a Loss of Speed delay. If a magnetic pickup is not installed, then speed sensing is performed by monitoring AC line frequency.
A	46	Shutdown	HIGH AC CURRENT	 46	Indicates that alternator output current (one or more phases) has exceeded 150% of the rated output current continuously for more than 10 seconds.
C	61	Shutdown	EMERGENCY STOP	 61	Indicates an Emergency Stop has been activated.
A	71	Shutdown	SPEED HZ MATCH	$N \neq \text{HZ}$ 71	Indicates that measured engine speed and measured alternator AC output frequency do not agree.
C	72	Shutdown	FAIL TO CRANK	 72	The genset has failed to sense rotation for two start attempts. This indicates a possible fault with the control, speed sensing, or the starting system.
C	73	Shutdown	FAIL TO START	 73	The genset has failed to start after a set number of crank attempts. This indicates a possible fuel system or air induction problem (engine cranks but fails to start).
B	74	Shutdown	FAIL TO STOP	 74	The genset continues to run after receiving a shutdown command from the controller.
D	75	Shutdown	Customer Input 1	 75	The nature of the fault is an optional customer selection.
D	76	Shutdown	Customer Input 2	 76	The nature of the fault is an optional customer selection.
D	81	Shutdown	Annunciator Fault 1	 81	The nature of the annunciator fault is an optional customer selection.
D	82	Shutdown	Annunciator Fault 2	 82	The nature of the annunciator fault is an optional customer selection.
D	83	Shutdown	Annunciator Fault 3	 83	The nature of the annunciator fault is an optional customer selection.
C	202	Warning	PRE-HIGH COOLANT TEMP	 202	Indicates engine is operating near cooling system capacity. Increase in load or higher ambient temperature may cause High Coolant Temp ( <b>code 1</b> ) shutdown.
C	203	Warning	LOW COOLANT TEMP	 203	Indicates that the engine coolant temperature is below the adjusted setpoint. This may indicate that the coolant heater is not operating or is not circulating coolant.
D	204	Warning	Customer Input 1	 204	The nature of the fault is an optional customer selection.
D	205	Warning	Customer Input 2	 205	The nature of the fault is an optional customer selection.

TABLE 5-1. FAULT CODES (CONT.)

CTG	CODE	LAMP	DISPLAYED MESSAGE/SYMBOLS		DESCRIPTION
			TEXT VERSION	SYMBOLIC VERSION	
B	212	Warning	COOLANT SENSOR OOR	 212	Indicates the coolant temperature sensor output is out of range (OOR), high or low.
C	213	Warning	LOW BATTERY	 213	Indicates battery voltage supply to the control is approaching a low level at which unpredictable operation can occur.
C	214	Warning	HIGH BATTERY	 214	Indicates battery voltage supply to the control is approaching a high level at which damage to the control can occur.
C	215	Warning	PRE-LOW OIL PRESSURE	 215	Indicates that the engine oil pressure is approaching an unacceptable level.
B	216	Warning	HIGH AC CURRENT	 216	Indicates that the alternator output current (one or more phases) has exceeded 130% of nominal, or has exceeded 110% of nominal for 60 seconds.
B	217	Warning	OIL PRESS SENSOR OOR	 217	Indicates the oil pressure sensor output is out of range (OOR), high or low.
B	219	Warning	CHARGER FAILURE	 219	Indicates the battery charging alternator has not reached a acceptable voltage range within the selected time period (default = 120 seconds).
C	221	Warning	WEAK BATTERY	 221	Indicates that the genset battery voltage is below battery thresholds during cranking.
D	222	Warning	Annunciator Fault 1	 222	The nature of the annunciator fault is an optional customer selection.
D	223	Warning	Annunciator Fault 2	 223	The nature of the annunciator fault is an optional customer selection.
D	224	Warning	Annunciator Fault 3	 224	The nature of the annunciator fault is an optional customer selection.
D	225	Warning	ANNUNCIATOR OUTPUT CONFIGURATION ERROR	 225	Indicates a mismatch in the configuration of one of the annunciator relay outputs.

**⚠ WARNING** Hazards present in troubleshooting can cause equipment damage, severe personal injury or death. Only trained and experienced service personnel with knowledge of fuels, electricity, and machinery hazards should perform service procedures. Read Important Safety Instructions pages and observe all instructions and precautions in this manual.

**TABLE 5-2. WARNING AND SHUTDOWN CODES**

FAULT CODE	CORRECTIVE ACTION
<b>1</b> <b>HIGH COOLANT TEMP</b> Lamp: Shutdown	Indicates engine has overheated (coolant temperature has risen above the shutdown trip point). Allow engine to cool down completely before proceeding with the following checks. <ol style="list-style-type: none"> <li>1. Check coolant level and replenish if low. Look for coolant leaks and repair if necessary.</li> <li>2. Check for obstructions to cooling airflow and correct as necessary.</li> <li>3. Check fan belt and repair or tighten if necessary.</li> <li>4. Check blower fan and circulation pumps on remote radiator installations.</li> <li>5. Reset control and restart after locating and correcting problem.</li> </ol>
<b>2</b> <b>LOW OIL PRESSURE</b> Lamp: Shutdown	Indicates engine oil pressure has dropped below the shutdown trip point. Check oil level. If oil level is low, replenish. Reset control and restart.
<b>15</b> <b>UNDER FREQUENCY</b> Lamp: Shutdown	Indicates possible fuel system problem or overload condition. <ol style="list-style-type: none"> <li>1. Check for dirty or plugged air filter and replace if necessary (see <i>Maintenance</i> sections).</li> <li>2. Check operation by disconnecting load and restarting generator set.</li> <li>3. Adjust fuel system (refer to <i>Section 7</i>).</li> <li>4. Gaseous fuel delivery to the set is inadequate. Contact an authorized service center for service.</li> <li>5. Reset the control and restart after correcting the problem.</li> </ol>
<b>61</b> <b>REMOTE E-STOP</b> Lamp: Shutdown	Indicates remote Emergency Stop activation. To reset the remote Emergency Stop button: <ol style="list-style-type: none"> <li>1. Deactivate (disable) remote emergency stop button.</li> <li>2. Move the rocker switch to the OFF position or press the OFF button.</li> <li>3. Select the desired operating mode (manual or remote).</li> </ol>
<b>72</b> <b>FAIL TO CRANK</b> Lamp: Shutdown	Indicates possible fault with control, speed sensing or starting system. See fault code <b>213</b> for corrective action.

**⚠ WARNING** Hazards present in troubleshooting can cause equipment damage, severe personal injury or death. Only trained and experienced service personnel with knowledge of fuels, electricity, and machinery hazards should perform service procedures. Read Important Safety Instructions pages and observe all instructions and precautions in this manual.

**TABLE 5-2. WARNING AND SHUTDOWN CODES (CONT.)**

FAULT CODE	CORRECTIVE ACTION
<b>73</b> <b>FAIL TO START</b> Lamp: Shutdown	Indicates possible fuel system problem. (Engine cranks but fails to start) <ol style="list-style-type: none"> <li>1. Open any closed fuel shutoff valve.</li> <li>2. Check for dirty or plugged air filter and replace if necessary.</li> <li>3. Gaseous fuel delivery to the set is inadequate. Contact an authorized service center for service.</li> <li>4. Reset the control and restart after correcting the problem.</li> </ol>
<b>76, 77</b> <b>CUSTOMER INPUT #1, #2</b> Lamp: Shutdown	The nature of the fault is an optional customer selection. Example inputs: Low Coolant Level, Low Fuel Pressure, Ground Fault, etc. Each of the fault functions can be programmed (using InPower service tool or access to Setup menu), as follows: <ul style="list-style-type: none"> <li>• Warning or Shutdown (Default = Warning) (See fault code <b>204/205</b> for Warning)</li> <li>• Change display name using up to 32 characters.</li> </ul>
<b>202</b> <b>PRE-HIGH COOL TMP</b> Lamp: Warning	Indicates engine is operating near cooling system capacity. Increase in load or higher ambient temperature may cause High Coolant Temp (1) shutdown. Review fault code 1 correction list for other possible causes.
<b>203</b> <b>LOW COOLANT TEMP</b> Lamp: Warning Set is not operating. Warning occurs when engine coolant temperature is 70° F (21° C) or lower. <b>NOTE: In applications where the ambient temperature falls below 40° F (4° C), Low Coolant Temp may be indicated even though the coolant heaters are operating.</b>	Indicates engine coolant heater is not operating or is not circulating coolant. Check for the following conditions: <ol style="list-style-type: none"> <li>1. Coolant heater not connected to power supply. Check for blown fuse or disconnected heater cord and correct as required.</li> <li>2. Check for low coolant level and replenish if required. Look for possible coolant leaks and repair as required.</li> </ol>
<b>204, 205</b> <b>CUSTOMER INPUT #1, #2</b> Lamp: Warning	The nature of the fault is an optional customer selection. Example inputs: Low Coolant Level, Low Fuel Pressure, Ground Fault, etc. Each of the fault functions can be programmed (using InPower service tool or access to Setup menu), as follows: <ul style="list-style-type: none"> <li>• Warning or Shutdown (Default = Warning) (See fault code <b>75/76</b> for Shutdown)</li> <li>• Change display name using up to 32 characters.</li> </ul>

**⚠ WARNING** Hazards present in troubleshooting can cause equipment damage, severe personal injury or death. Only trained and experienced service personnel with knowledge of fuels, electricity, and machinery hazards should perform service procedures. Read Important Safety Instructions pages and observe all instructions and precautions in this manual.

**TABLE 5-2. WARNING AND SHUTDOWN CODES (CONT.)**

FAULT CODE	CORRECTIVE ACTION
<b>213</b> <b>LOW BATTERY</b> Lamp: Warning	Indicates battery voltage supply to the control is approaching a low level at which unpredictable operation will occur. <ol style="list-style-type: none"> <li>1. Discharged or defective battery.               <ol style="list-style-type: none"> <li>a. Check the battery charger fuse.</li> <li>b. Recharge or replace the battery.</li> </ol> </li> <li>2. Poor battery cable connections. Clean the battery cable terminals and tighten all connections.</li> <li>3. Check battery charge voltage float level if applicable (raise float level).</li> </ol>
<b>214</b> <b>HIGH BATTERY</b> Lamp: Warning	Indicates battery voltage supply to the control is approaching a high level at which damage to the control can occur. Check float level on battery charger if applicable (lower float level).
<b>215</b> <b>PRE-LOW OIL PRES</b> Lamp: Warning	Indicates engine oil pressure has dropped to an unacceptable level. If generator is powering critical loads and cannot be shut down, wait until next shutdown period and then follow fault code 2 procedure.
<b>221</b> <b>WEAK BATTERY</b> Lamp: Warning	Indicates that during cranking, the battery voltage is at or below the weak battery warning trip point for a time greater than or equal to the weak battery set time. See code 213 for corrective action.

## CONTROL PANEL FUSES

After replacing an opened fuse, and the fuse re-opens, contact an authorized service center for service.

### Customer Switched B+

If any external customer connected controls or indicators fail to function that are powered by genset

switched B+, replace the Customer Switched B+ (15A) fuse.

### Voltage Reference

The generator set will shut down and may display Fault Code 13 or 27 if this fuse opens. This fuse protects the PCC control circuitry from damage due to a generator fault condition.

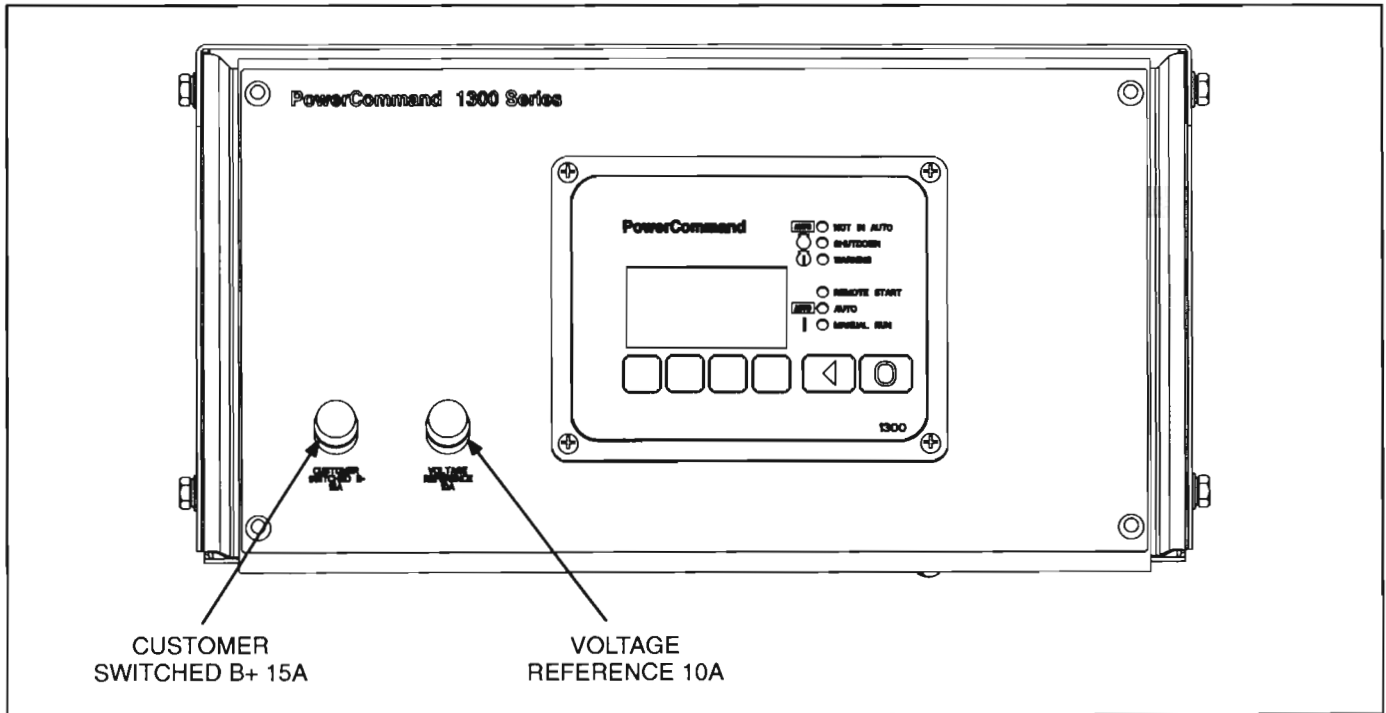

FIGURE 1-1. CONTROL PANEL FUSES



**THIS PAGE LEFT INTENTIONALLY BLANK**

# 6. Maintenance

---

## GENERAL

Establish and adhere to a definite schedule for maintenance and service based on the application and severity of the environment. Table 6-1 covers the recommended service intervals for a generator set on STANDBY service. If the generator set will be subjected to extreme operating conditions, the time between service intervals should be reduced accordingly. Some of the factors that can affect the maintenance schedule are the following:

- Use for continuous duty (prime power)
- Extremes in ambient temperature
- Exposure to weather

- Exposure to salt water
- Exposure to dust, sand or other airborne contaminants.

Consult with your local Cummins Power Generation distributor if the generator set will be subjected to any extreme operating conditions and determine a suitable schedule of maintenance. Use the running time meter to keep an accurate log of all service performed for warranty support. Perform all service at the time period indicated or after the number of operating hours indicated, whichever comes first. Use Table 6-1 to determine the maintenance required and then refer to the sections that follow for the correct service procedures.

**TABLE 6-1. PERIODIC MAINTENANCE SCHEDULE**

MAINTENANCE ITEMS	SERVICE TIME				
	Daily or after 8 Hours	Monthly or after 100 Hours	After 100 Hours	6 Months or after 250 Hours	Yearly or after 500 Hours
General set inspection	X <sup>1</sup>				
Check engine oil level	X				
Check coolant level	X				
Check coolant heater(s)	X				
Check air cleaner (normal duty filter)		X <sup>2,3</sup>			
Check all hardware (fittings, clamps, fasteners, etc.)		X			
Check battery electrolyte level		X			
Check generator air outlet		X			
Change engine oil and filter (normal duty filter)			X <sup>2,7</sup>		
Check radiator hoses for wear and cracks				X <sup>4</sup>	
Check drive belt				X <sup>5</sup>	
Check anti-freeze concentration				X	
Check AC generator and controls				X	
Clean cooling systems					X
Inspect or replace spark plugs					X <sup>6</sup>

X<sup>1</sup> - Check for oil, fuel, cooling and exhaust system leaks. Check exhaust system audibly and visually with set running and repair any leaks immediately.

X<sup>2</sup> - Perform more often in extremely dusty conditions.

X<sup>3</sup> - Replace element after 500 hours.

X<sup>4</sup> - Replace if hard or brittle.

X<sup>5</sup> - Visually check belt for evidence of wear or slippage. Replace if hard or brittle.

X<sup>6</sup> - Replace every 1,000 hours.

X<sup>7</sup> - Perform at least once a year.

## GENERATOR SET INSPECTION

During operation, be alert for mechanical problems that could create unsafe or hazardous conditions. The following sections cover several areas that should be frequently inspected for continued safe operation.

### Exhaust System

With the generator set operating, inspect the entire exhaust system visually and audibly, including the exhaust manifold, muffler, and exhaust pipe. Check for leaks at all connections, welds, gaskets, and joints and also make sure that exhaust pipes are not heating surrounding areas excessively. If any leaks are detected, shut down the generator set and have leaks corrected immediately.

**⚠WARNING** *Inhalation of exhaust gases can result in severe personal injury or death. Be sure deadly exhaust gas is piped outside and away from any windows, doors, vents or other inlets to building and not allowed to accumulate in inhabitable areas.*

### Fuel System

With the generator set operating, inspect the fuel supply lines and fittings for leaks. Check any flexible sections for cuts, cracks and abrasions and make sure they are not rubbing against anything that could cause breakage. If any leaks are detected, shut off fuel supply valves, shut down generator set and have them corrected immediately.

**⚠WARNING** *Ignition of fuel can cause severe personal injury or death by fire or explosion. Do not permit any flame, cigarette, arcing switch or equipment, pilot light, or other igniter near the fuel system or in areas sharing ventilation.*

### AC Electric System

Check the following while the generator set is operating.

**Frequency/RPM (Alternator/Engine Menu):** The generator frequency should be stable under load and the reading should be the same as the generator set nameplate rating (50 or 60 Hz/1500 or 1800 RPM). Under no-load conditions the frequency can vary between 50–53 or 60–63 Hz.

**AC Voltmeter (Alternator Menu):** At no load, the line-to-line or line-to-neutral voltage(s) should be the same as the generator set nameplate rating.

**AC Ammeter (Alternator Menu):** At no load the current ratings should be zero. With a load applied, each line current should be about the same.

### DC Electrical System

Check the terminals on the batteries for clean and tight connections. Loose or corroded connections create resistance which can hinder starting. Refer to *BATTERIES* later in this section for cleaning and safety precautions.

### Engine

Monitor fluid levels, oil pressure and coolant temperatures frequently. Most engine problems give an early warning. Look and listen for changes in engine performance, sound, or appearance that can indicate service or repair is needed. Some engine changes to look for are as follows:

- Misfire
- Vibration
- Unusual noises
- Sudden changes in engine operating temperatures or pressures
- Excessive exhaust smoke
- Loss of power
- An increase in oil consumption
- An increase in fuel consumption
- Fuel, oil, or coolant leaks.

## GENERATOR SET MAINTENANCE (Battery Disconnected)

**⚠ WARNING** Ignition of explosive battery gases can cause severe personal injury or death. Arcing at battery terminals, light switch or other equipment, flame, pilot lights and sparks can ignite battery gas. Do not smoke, or switch trouble light ON or OFF near battery. Discharge static electricity from body before touching batteries by first touching a grounded metal surface.

Ventilate battery area before working on or near battery—Wear goggles—Stop genset and disconnect charger before disconnecting battery cables—Disconnect negative (-) cable first and reconnect last.

**⚠ CAUTION** Disconnect battery charger from AC source before disconnecting battery cables. Otherwise, disconnecting cables can result in voltage spikes damaging to DC control circuits of the generator set.

**⚠ WARNING** Accidental starting of the generator set can cause severe personal injury or death. Prevent accidental starting by disconnecting the negative (-) cable from the battery terminal before beginning maintenance procedures.

When performing the following maintenance procedures, make certain the generator set cannot be accidentally restarted as follows:

1. Without Display: Move the Start/Off/Remote switch on the control panel to the OFF position.

With Display: Press the  button to switch to the Off mode.

2. Turn off or remove AC power from the battery charger.
3. Remove the negative (-) battery cable from the generator set starting battery.

### Mechanical Inspection

With the generator set stopped, check for loose belts and fittings, leaking gaskets and hoses, or any signs of mechanical damage. If any problems are found, have them corrected immediately.

## LUBRICATION SYSTEM

Before the initial start, check dipstick to be sure crankcase is filled with oil. See *Specifications* section for lubricating oil capacity.

**Gensets are shipped with oil added. Be sure to check oil level before initial start.**

### Oil Recommendations

Refer to Figure 6-1 for the recommended oil viscosity grades at various ambient temperatures. Oils must conform to the American Petroleum Institute (API) classification SJ or SJ/CD. When selecting the oil viscosity, pick the grade that is right for the lowest temperature expected. Oil that is too thick can result in a lack of lubrication when the engine is started. If the ambient temperature is consistently below  $-13^{\circ}\text{F}$  ( $-25^{\circ}\text{C}$ ), use a SAE5W *synthetic* oil.

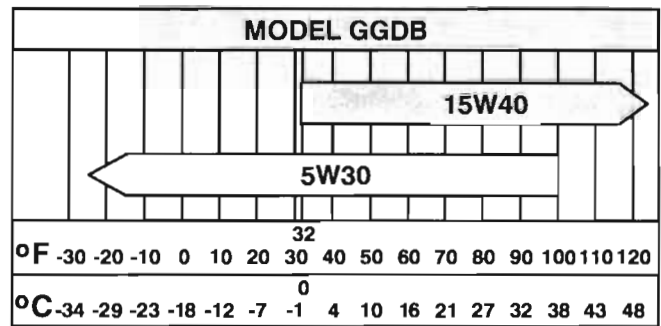

FIGURE 6-1. OIL VISCOSITY

## Engine Oil Level

Check the engine oil level during engine shutdown periods at the intervals specified in the Maintenance Table. The dipstick is stamped with FULL and ADD to indicate the level of oil in the crankcase. For accurate readings, shut off the engine and wait approximately 10 minutes before checking the engine oil level. This allows oil in the upper portion of the engine to drain back into the crankcase.

**⚠ WARNING** *Crankcase pressure can blow out hot oil and cause severe burns. Do NOT check oil while the generator set is operating.*

Keep the oil level as near as possible to the FULL mark on the dipstick. Remove the oil fill cap and add oil of the same quality and brand when necessary.

**⚠ CAUTION** *Do not operate the engine with the oil level below the ADD mark or above the FULL mark. Overfilling can cause foaming or aeration of the oil. Operation below the ADD mark can cause loss of oil pressure.*

## Engine Oil Change

**⚠ WARNING** *State or federal agencies have determined that contact with used engine oil can cause cancer or reproductive toxicity. Do not contact oil or breath vapors. Use rubber gloves and wash exposed skin.*

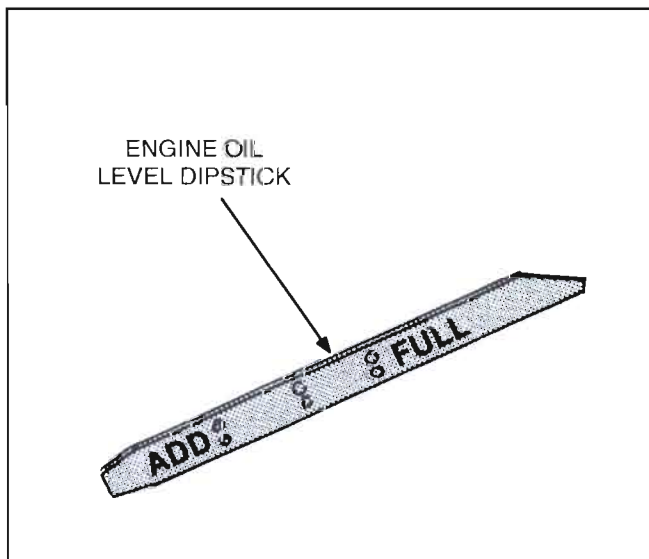

FIGURE: 6-2. OIL LEVEL DIPSTICK

*Used oil and filters must be disposed of properly to avoid environmental damage and clean-up liability. Check all federal, state and local regulations for disposal requirements.*

Run engine until thoroughly warm before draining oil. Stop the generator set, place a pan under the drain outlet and remove the oil drain plug or open the drain valve. After the oil is completely drained, replace the drain plug or close the drain valve. Refill with oil of the correct API viscosity grade for the temperature conditions.

**⚠ WARNING** *Hot crankcase oil can cause burns if it is spilled or splashed on skin. Keep fingers and hands clear when removing the oil drain plug and wear protective clothing.*

## Oil Filter Change

Spin off oil filter and discard it in accordance with local environmental regulations. Thoroughly clean filter mounting surface. Apply a thin film of oil to filter gasket and install new element. Spin element on by hand until gasket just touches mounting pad and then turn an additional 1/2 to 3/4 turn. Do not over-tighten (Figure 6-3).

With oil in crankcase, start engine and check for leaks around filter element. Retighten only as much as necessary to eliminate leaks but do not over-tighten.

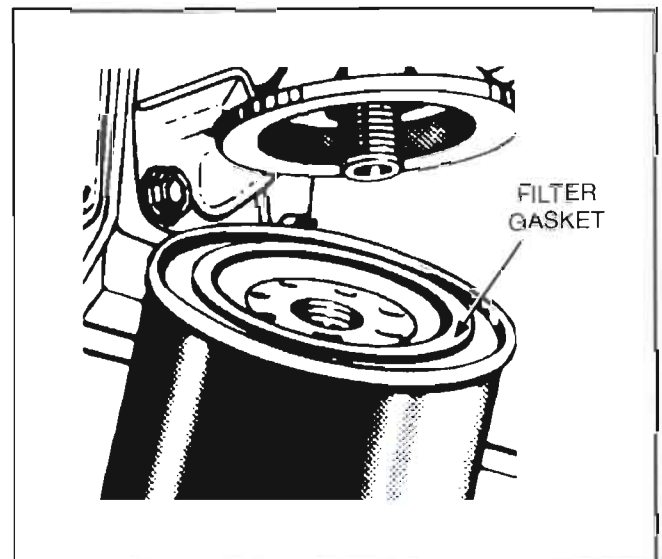

FIGURE: 6-3. ENGINE OIL FILTER

## COOLING SYSTEM

The cooling system capacity of a standard unit with generator set mounted radiator is shown in Specifications section.

**Gensets are shipped with coolant added. Be sure to check coolant level before initial start.**

### Coolant Requirements

The water used for engine coolant should be clean, low in mineral content and free of any corrosive chemicals such as chloride, sulfate or acid. Generally, any water that is suitable for drinking can be treated for use as engine coolant. Cooling system coolant must also have corrosion inhibitors.

Cooling systems that are subjected to freezing conditions must also be protected with a permanent type antifreeze. Use a 50/50 coolant solution (50% pure water and 50% antifreeze). Do not use an antifreeze that contains anti-leak additives.

### Filling the Cooling System

**CAUTION** *Do not add cold coolant to a hot engine. Engine castings can be damaged. Allow the engine to cool to below 120° F (50° C) before adding coolant.*

Verify that all drain cocks are closed and all hose clamps secure. Remove the radiator pressure cap and slowly fill the cooling system with the recommended coolant.

When the engine is first started, remove the pressure cap and monitor the coolant level. As trapped air is expelled from the system, the coolant level may drop and additional coolant must be added. Replace the pressure cap when the coolant level is stable.

### Coolant Level

Check the coolant level during shutdown periods at the intervals shown in Table 6-1. Remove the radiator cap after allowing the engine to cool and if necessary, add coolant until the level is near the top of the radiator.

**WARNING** *To prevent severe scalding, let engine cool down before removing coolant pressure cap. Turn cap slowly, and do not open it fully until the pressure has been relieved.*

**CAUTION** *Loss of coolant can allow engine to overheat without protection of shutdown device and cause severe damage to the engine. Maintain coolant level for proper operation of the high engine temperature shutdown system.*



## Draining and Flushing

**⚠ WARNING** *Some coolant is toxic. Keep away from children and animals. Follow local environmental regulations for disposal.*

To maintain adequate corrosion protection and remove rust and scale deposits, drain and flush radiator at the recommended interval.

**⚠ CAUTION** *The heater element will burn out if engine coolant is removed with heater connected to power source.*

Disconnect engine coolant heater from power source (if equipped).

Allow the engine to cool and then remove radiator pressure cap. Open the radiator drain cock and remove the coolant hose as shown in Figure 6-4. When the coolant is drained, place the end of a water hose into the radiator filler and turn on water supply. Regulate the flow of water into the radiator until it is equal to the outflow from drain openings. Continue flushing until outflow from drains is clear of rust sediment.

If engine is equipped with engine coolant heater, drain coolant by removing hose and clamp from bottom of heater.

Install the coolant/drain plug and close the radiator drain cock when flushing is complete. Refill the cooling system with the recommended coolant (refer to *Filling the Cooling System*).

With cooling system properly filled, connect heater plug to receptacle.

## Radiator

Inspect the exterior of the radiator for obstructions. Remove all dirt or foreign material with a soft brush or cloth. Use care to avoid damaging the fins. If available, use low pressure compressed air or stream of water (maximum of 35 psi/242 kPa), in opposite direction of normal air flow to clean radiator. If using water, protect the engine and the generator from over spray.

## Coolant Heater

Check the operation of the coolant heater by verifying that hot coolant is being discharged from the outlet hose. **Do not touch outlet hose** – if heater is operational, radiant heat should be felt with hand held close to outlet hose.

**⚠ WARNING** *Contact with cooling system or engine can result in serious burns. Do not touch cooling system or engine during genset maintenance until they are cool.*

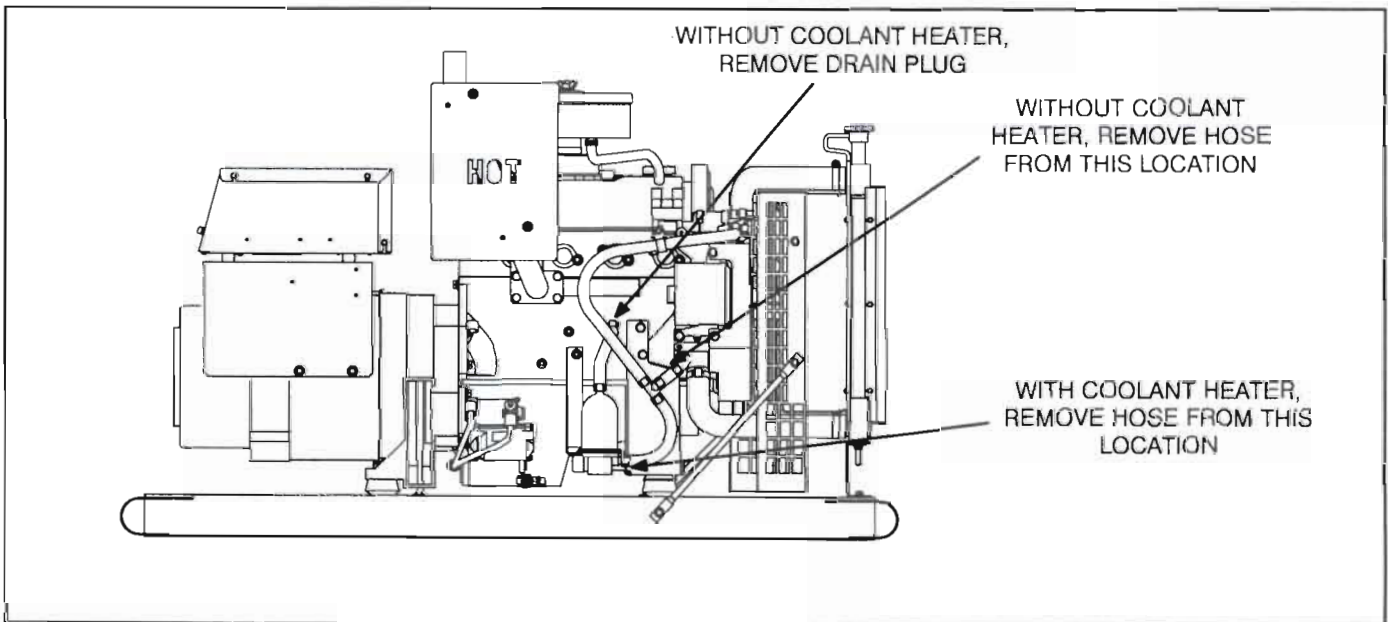

FIGURE 6-4. COOLANT HEATER

## AIR FILTER

**CAUTION** *Filters should be handled with care to prevent damage. If the filter does become damaged, install recommended replacement part.*

Remove wing nut in center of filter cover (Figure 6-5). Remove cover and filter. Tap filter on a flat surface to remove dirt. Place a light source inside filter and inspect for air passage. If necessary, apply a low pressure air source (30 psi) to the inside of filter to remove as much dirt as possible. Inspect interior housing. Vacuum clean if dirty or remove lower housing and wipe clean. If removing lower housing, disconnect the breather hose from the valve cover, not from the bottom of lower housing.

**CAUTION** *Do not clean filter housing while still installed. Loose dirt entering intake could damage carburetor or engine.*

Clean air filter every 100 hours of operational time, more often in extremely dusty conditions. Replace air filter after 500 hours of operational time.

## DRIVE BELT

The alternator, water pump and fan are driven by a single belt. The belt tension is maintained by a belt tensioner and does not require adjustment.

Inspect the belt at the recommended intervals. Replace a worn or damaged belt before belt failure occurs. A defective or broken belt will cause overheating and insufficient battery charging.

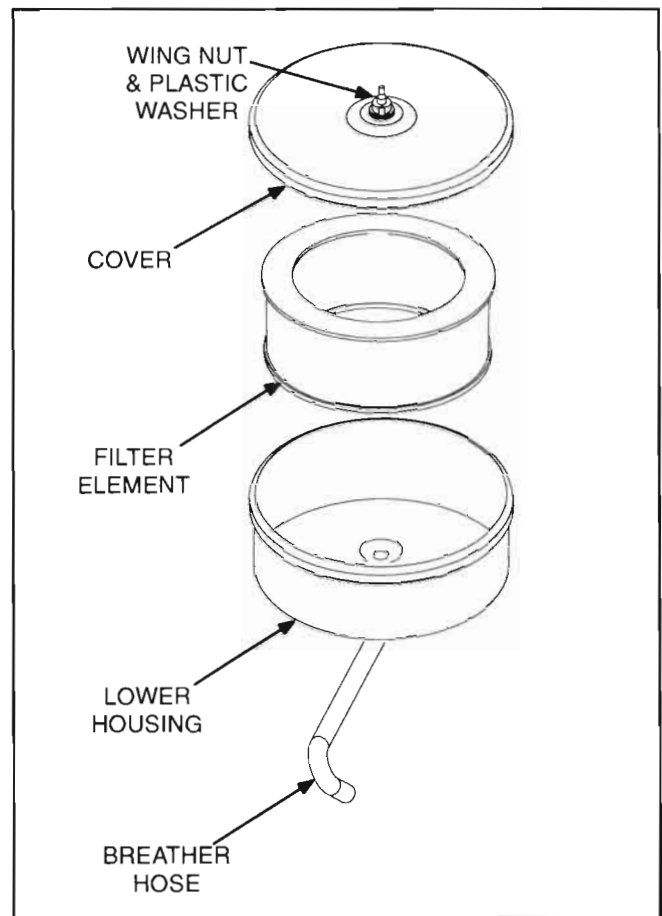

FIGURE 6-5. TYPICAL AIR CLEANER

## IGNITION SYSTEM

The ignition system consists of the ignition coil, high tension wires, spark plugs and electronic control module. Maintenance consists of periodic inspections to detect possible problems and replacement of worn or deteriorated parts. The ignition system must be completely functional or the generator set may run poorly or be unable to carry full load. Perform the following inspections at recommended intervals.

### Spark Plugs

Remove the spark plugs and inspect for damaged or cracked insulators, worn electrodes, damaged gaskets or excessive carbon deposits. Replace the spark plug if any of these conditions are noted. Clean those plugs that can be reused and regap (Figure 6-6) to the amount specified in the Specifications section. Clean all dirt and grit away from the spark plug seats before installing plugs.

If the spark plugs show any of the following conditions, the engine may require additional service. Contact your authorized service distributor for help.

- Carbon Fouled - Overly Rich Mixture
- Oil Fouled - High oil consumption
- Burned - Excessive engine temperature

### High Tension Wires

Check the spark plug wires and coil wire for good contact at the coil and spark plugs. Terminal connections should be tight and fully seated. All spark plug covers and cable end boots should be in good condition and fit tightly. There should be no breaks or cracks in the insulation. Replace the wire if any of these conditions are noted.

**CAUTION** *High tension wires can be damaged if removed incorrectly from terminals. Grasp wire by spark plug boot to prevent damage to conductor.*

### Ignition Coil

Clean the top of the ignition coil and check for cracks, carbon tracks or corrosion in the high tension terminal hole. Replace the coil if any of these conditions are noted.

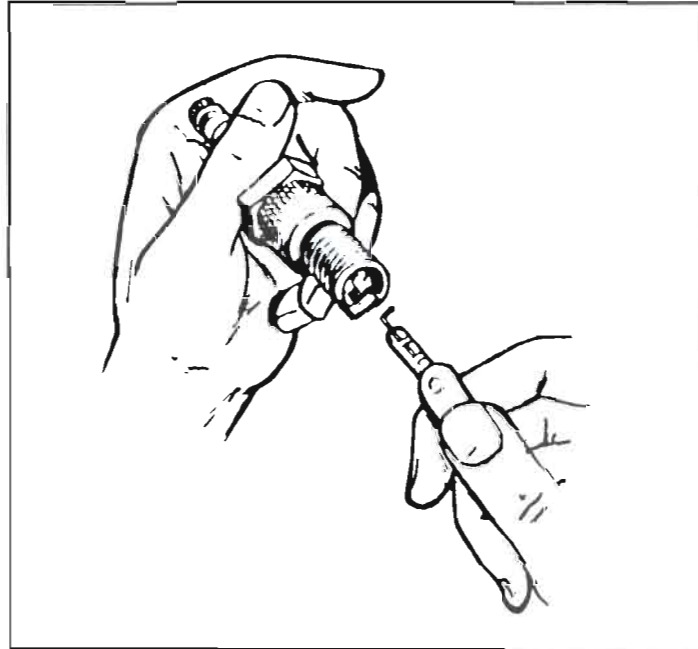

FIGURE 6-6. GAPPING SPARK PLUGS

## BATTERIES

**⚠ WARNING** *Ignition of explosive battery gases can cause severe personal injury or death. Arcing at battery terminals, light switch or other equipment, flame, pilot lights and sparks can ignite battery gas. Do not smoke, or switch trouble light ON or OFF near battery. Discharge static electricity from body before touching batteries by first touching a grounded metal surface.*

*Ventilate battery area before working on or near battery—Wear goggles—Stop genset and disconnect charger before disconnecting battery cables—Disconnect negative (-) cable first and reconnect last.*

**⚠ CAUTION** *Disconnect battery charger from AC source before disconnecting battery cables. Otherwise, disconnecting cables can result in voltage spikes damaging to DC control circuits of the generator set.*

Check the condition of the starting batteries at the interval specified in the Maintenance Table. To prevent dangerous arcing, always disconnect the negative ground cable from the battery before working on any part of the electrical system or the engine. Disregard the sections On Checking Specific Gravity and Checking Electrolyte Level if using a “maintenance-free” battery.

### Cleaning Batteries

**⚠ WARNING** *Electrolyte is a dilute sulfuric acid that is harmful to the skin and eyes. Do not get the substance in your eyes or contact with skin. Wear goggles and protective, rubber gloves and apron when servicing batteries.*

*In case of contact, immediately wash skin with soap and water. In case of contact, immediately flood eyes with large amounts of water for a minimum of 15 minutes. IMMEDIATELY CALL A PHYSICIAN.*

Keep the batteries clean by wiping them with a damp cloth whenever dirt appears excessive.

If corrosion is present around the terminal connections, remove battery cables and wash the terminals with a solution consisting of 1/4 pound of baking soda added to 1 quart of water. (This solution is also used for washing down spilled electrolyte.)

Be sure the vent plugs are tight to prevent cleaning solution from entering the cells.

After cleaning, flush the outside of the battery and surrounding areas with clean water.

Keep the battery terminals clean and tight. After making connections, coat the terminals with a light application of petroleum jelly or non-conductive grease to retard corrosion.

### Checking Specific Gravity

Use a battery hydrometer to check the specific gravity of the electrolyte in each battery cell.

Hold the hydrometer vertical and take the reading. Correct the reading by adding four gravity points (0.004) for every ten degrees the electrolyte temperature is above 80° F (27° C). A fully charged battery will have a corrected specific gravity of 1.260. Charge the battery if the reading is below 1.215.

### Checking Electrolyte Level

**⚠ CAUTION** *Do not add water in freezing weather unless the engine will run long enough (two to three hours) to assure a thorough mixing of water and electrolyte.*

Check the level of the electrolyte (acid and water solution) in the batteries at least every 200 hours of operation.

Fill the battery cells to the bottom of the filler neck. If cells are low on water, add distilled water and recharge. If one cell is low, check case for leaks. Keep the battery case clean and dry. An accumulation of moisture will lead to a more rapid discharge and battery failure.

## Battery Replacement

Always replace the starting battery with the same number and type (vented, lead acid). Properly dispose of battery in accordance with local environmental agency requirements.

**⚠WARNING** *Electrolyte or explosion of battery can cause severe personal injury or death. Do not mutilate or burn the battery in a fire for disposal.*

*Damage to case will release electrolyte which is harmful to the skin and eyes and is also toxic. Burning of battery may cause an explosion.*

## NiCad Batteries

NiCad (nickel-cadmium) battery systems are often specified where extreme high or low ambient temperature is expected because their performance is less affected by temperature extremes than that of lead-acid batteries.

NiCad batteries require special battery chargers in order to bring them to the full-charge level. These chargers must be provided with filter to reduce "charge ripple" which can disrupt engine and generator control systems.

## OUT-OF-SERVICE PROTECTION

When the generator set will be stored or removed from operation for an extended period of time, take the following precautions to prevent rust accumulation, corrosion of bearing surfaces within the engine and gum formation in the fuel system. Perform the following procedures as outlined in this manual.

### Preparing Generator Set for Storage

1. Exercise the generator set as described in Operation section until the engine is up to operating temperature.
2. Shut down the engine.
3. Turn off and disconnect battery charger (if equipped).
4. Disconnect battery (negative [-] first) and store in a cool, dry place. Connect battery to charger every 30 days to maintain it at full charge.
5. Drain the engine oil while still warm and refill with new oil recommended for generator set. Attach a tag indicating type of oil used.
6. Remove the spark plugs and pour two ounces of rust preventative oil into each spark plug opening. Crank the generator set for five seconds to distribute the oil on the cylinder walls and then replace the spark plugs.
7. Disconnect engine coolant heater from power source (if equipped).
8. Drain the cooling system including the engine block.

9. Remove the air cleaner and seal off the carburetor air inlet opening and PVC hose.
10. Plug the exhaust outlets to prevent entrance of moisture, bugs, dirt, etc.
11. Clean and wipe entire unit. Coat parts susceptible to rust with a light coat of oil. Cover entire generator set loosely after engine has cooled down.

### Returning Generator Set to Service

1. Remove protective cover.
2. Remove exhaust plugs, seal from carburetor and PVC hose and replace air cleaner.
3. Check oil dipstick to make sure crankcase is full.
4. Refill cooling system.
5. Reconnect battery (positive [+] cable first) and check specific gravity.
6. Connect the battery charger (if applicable).
7. Connect engine coolant heater to power supply (if applicable).
8. Remove all loads before starting generator set.
9. Start generator set and apply load of at least 50% of nameplate rating.
10. Check all gauges for normal readings. Generator set is now ready for service.

**THIS PAGE LEFT INTENTIONALLY BLANK**

# 7. Adjustments

---

## FUEL SYSTEM ADJUSTMENTS

The engine is equipped with a gas mixer to run on natural gas or LPG or both.

If the fuel system is not properly adjusted, the set may lack power under full load and possibly cause an under frequency shut down (fault code 15).

**⚠ WARNING** *Fuel is highly flammable and may cause severe personal injury and property damage. Do not allow cigarettes, flame, pilot lights, arching switches or equipment in area or areas sharing ventilation.*

### Combination Fuel Systems

An engine equipped for natural gas and LPG has a gas mixer that serves both fuels. Each fuel has a separate shutoff solenoid valve and a fuel pressure switch for automatic fuel changeover.

While the engine is running and natural gas pressure is lost, the gas pressure switch causes the natural gas solenoid valve to close and the LPG solenoid valve to open, without stopping the engine. When natural gas pressure is restored, the natural gas solenoid valve opens and the LPG solenoid valve closes.

**Gaseous Fuel Adjustments:** The fuel system contains a main fuel valve, which may require adjustment (see Figure 7-1).

Engines equipped for natural gas and propane (dual fuel) also have a propane flow adjustment valve. If necessary, make the following adjustments.

**For applications in emission sensitive areas, final adjustment of the fuel/air ratio should be set using an exhaust gas analyzer.**

1. Start the engine and let the set warm up under a partial load (at least 1/4 rated load). If the engine is equipped for natural gas and propane, start with natural gas.
2. Connect full rated load and turn the main fuel valve two turns counterclockwise. Slowly turn the main fuel valve clockwise (lean) until the engine begins to lose speed and then slowly counterclockwise (rich) until the engine carries the full load smoothly.
3. If the set is equipped for natural gas and LPG, switch to LPG by closing the manual shutoff valve in the natural gas supply line.
4. Connect full rated load and turn the LPG flow adjustment valve clockwise until the engine begins to lose speed and then slowly turn it back counterclockwise until the engine carries full load smoothly.



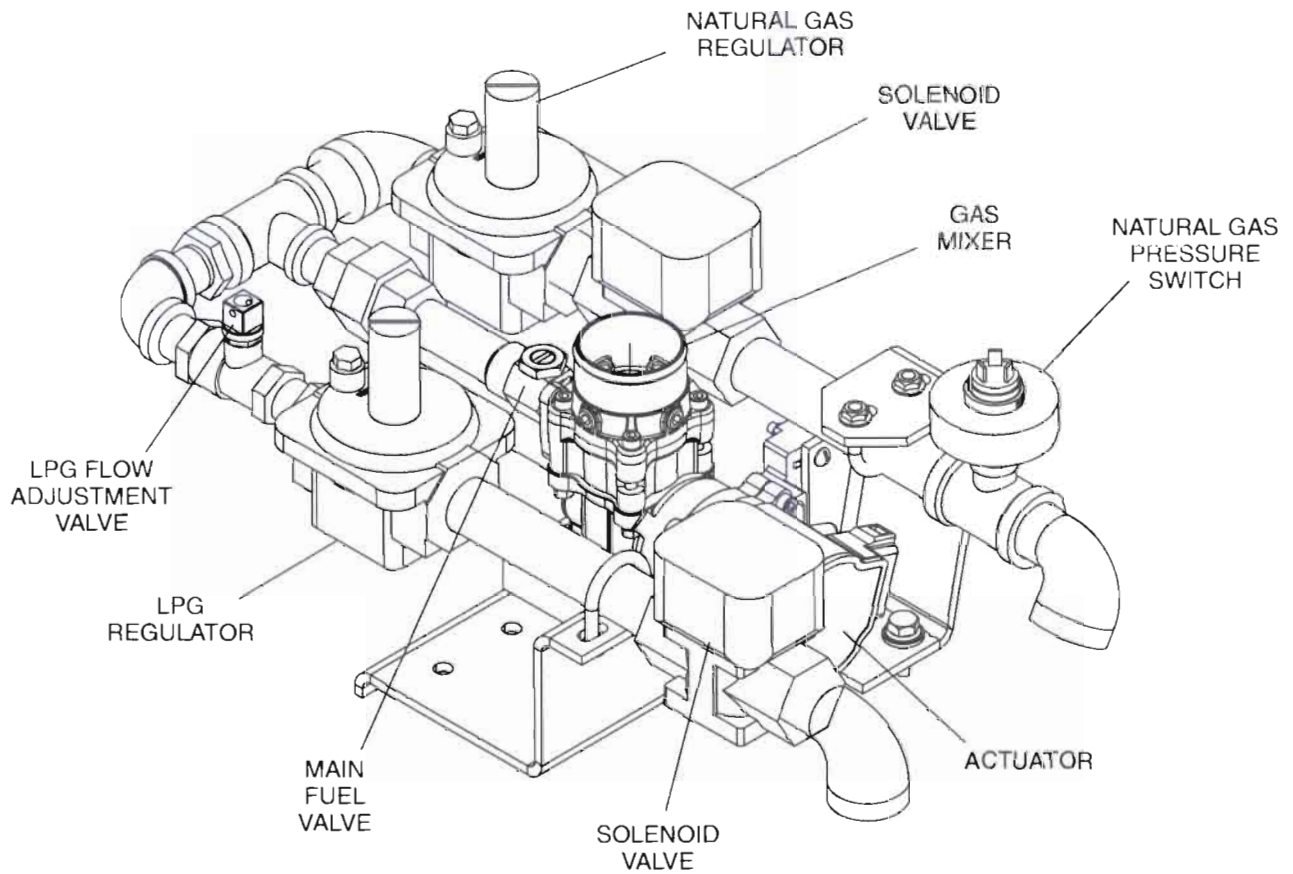

**DUAL FUEL SYSTEM**

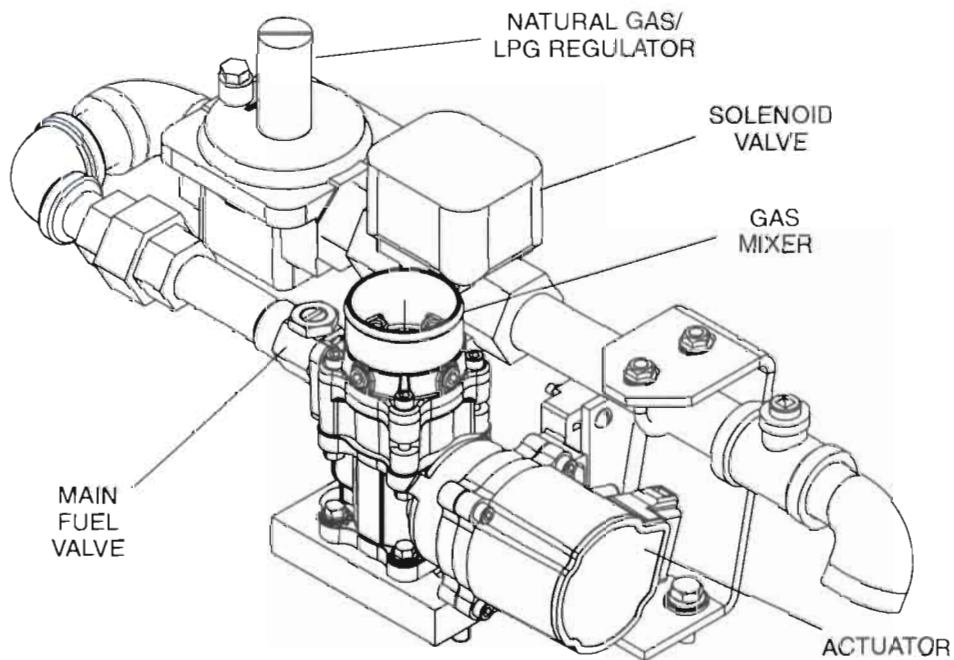

**SINGLE FUEL SYSTEM (NG OR LPG VAPOR)**

**FIGURE 7-1. NATURAL GAS AND LPG VAPOR FUEL SYSTEMS**

# 8. Operating Recommendations

---

## BREAK-IN

Drain and replace the crankcase oil after the first 50 hours of operation on new generator sets. Refer to the *Maintenance* section of this manual for the recommended procedures.

## NO-LOAD OPERATION

Periods of no load operation should be held to a minimum. If it is necessary to keep the engine running for long periods of time when no electric output is required, best engine performance will be obtained by connecting a load bank of at least 30 percent of nameplate rating.

## EXERCISE PERIOD

Generator sets on continuous standby must be able to go from a cold start to being fully operational in a matter of seconds. This can impose a severe burden on engine parts.

Regular exercising keeps engine parts lubricated, prevents oxidation of electrical contacts and in general helps provide reliable engine starting.

Exercise the generator set at least once a month for a minimum of 30 minutes, under not less than 30 percent of the nameplate rating.

## LOW OPERATING TEMPERATURE

Use a coolant heater if a separate source of power is available. The optional heater will help provide reliable starting under adverse weather conditions. Be sure the voltage of the separate power source is correct for the heater element rating.

**⚠ CAUTION** *To avoid damage to heater, be sure the cooling system is full before applying power to the heater.*

## HIGH OPERATING TEMPERATURE

Refer to the genset nameplate for the maximum ambient operating temperature, if applicable.

**THIS PAGE LEFT INTENTIONALLY BLANK**

**Cummins Power Generation**  
1400 73rd Avenue N.E.  
Minneapolis, MN 55432  
1-800-888-6626  
763-574-5000 International Use  
Fax: 763-528-7229

Cummins is a registered trademark of Cummins Inc.



**Power  
Generation**