

Crestron **CNX-PVID8x4**
Video Distribution Switch

Operations Guide



This document was prepared and written by the Technical Documentation department at:



Crestron Electronics, Inc.
15 Volvo Drive
Rockleigh, NJ 07647
1-888-CRESTRON

Contents

Professional Video Distribution Switch: CNX-PVID8x4	1
Introduction	1
Features and Functions	1
Specifications	3
Physical Description	4
Industry Compliance	8
Setup	8
Network Wiring	8
Identity Code	9
Cabling and Jumpers	10
Rack Mounting	11
Stacking	12
Hardware Hookup	13
Hardware Configurations	14
Signal Distribution to More than Eight Rooms	19
Programming Software	20
Earliest Version Software Requirements for the PC	20
Programming with Crestron AppBuilder	21
Programming with SIMPL Windows	21
CNX-PVID8x4 Symbols	23
Example Program	30
Uploading and Upgrading	31
Communication Settings	31
Uploading a SIMPL Windows Program	33
Firmware Upgrade	35
Problem Solving	36
Troubleshooting	36
Further Inquiries	37
Future Updates	37
Return and Warranty Policies	38
Merchandise Returns / Repair Service	38
CRESTRON Limited Warranty	38

Professional Video Distribution Switch: CNX-PVID8x4

Introduction

Features and Functions

The Crestron® Professional Video Distribution Switch, CNX-PVID8x4, is a CAT5 video distribution system that is capable of delivering video from a large number of separate video sources like DVD players, DSS receivers, tuners, VCRs, and cameras into a multitude of separate rooms or areas. The exact number of input sources and output destinations depend on how the unit is to be used in a system and whether or not it is connected to a Crestron Room Solution Box (CNXRMC or CNXRMCLV).

Its unique design and phenomenal flexibility remove design and installation constraints from residential systems integration. This unit can provide professional quality far above the level of consumer-grade equipment for sophisticated home theaters, kitchens, bedrooms, offices, and outdoor areas. Fully integrated with the Crestron control system as a network device, the CNX-PVID8x4 is a key component in the Crestron Home® complete solution for distributing audio, video, and control throughout the home.

Functional Summary

- Accepts digital audio, NTSC/PAL composite, component, and S-video sources, including HDTV
- Distributes up to 64 separate video sources to as many as 32 separate rooms
- Four levels of video matrix boards; each with 16 RCA inputs and 8 RCA outputs
- Each input includes two RCA connectors wired in parallel; one for video input, one for termination or loop-through
- Each input has built-in video sync sensor to report power/activity status of source device
- RCA output jacks provide single-ended (local mode) video
- Eight RJ-45 connectors provide digital audio and differential (CAT5 mode) video to up to eight rooms
- Internal jumpers and programming enable extensive input/output configuration flexibility

The CNX-PVID8x4 accepts digital audio, component, S-video, and NTSC/PAL composite sources, including HDTV signals, and distributes them to display devices throughout the home via standard CAT5 structured wiring. This distribution method ensures a balanced signal for long runs, allowing the user to equalize, adjust, and boost the gain of the video signal for the perfect picture for every application, in every room.

The CNX-PVID8x4 is designed with three levels of video inputs and outputs, each highly configurable for a variety of video formats. Each of the three levels of switcher boards implements a video matrix with 16 RCA inputs and eight RCA outputs for direct single ended video connection to local display devices. A fourth level may be used for 16 channels of distributed digital audio. In addition, the CNX-PVID8x4 contains eight RJ-45 outputs for distributing any of these audio/video signals via CAT5 mode for differential audio/video to up to eight rooms throughout the house. No matter what the configuration, all inputs have a built-in video sync sensor that reports power/activity status of all source devices attached to the CNX-PVID8x4.

CNX-PVID8x4 used with Crestron Room Solution Box

NOTE: Systems that incorporate the CNX-PVID8x4 and Crestron Room Solution Boxes satisfy a vast number of possible applications that could be used by Crestron customers.

The CNXPVID8x4 is ideally used in tandem with a CNXRMC or CNXRMCLV in each room, which receives and decodes the CAT5 video from the CNX-PVID8x4 and supplies it to the display device in the room. Refer to an illustration of a general application scenario after this paragraph. This video distribution solution, combined with Crestron's audio distribution switches (CNX-PAD8A or CNX-BIPAD8), a Crestron CNAMPX intelligent amplifier, and a 2-Series control system, creates a complete networked audio/video/control solution for the connected home.

General Application Scenario of the CNX-PVID8x4

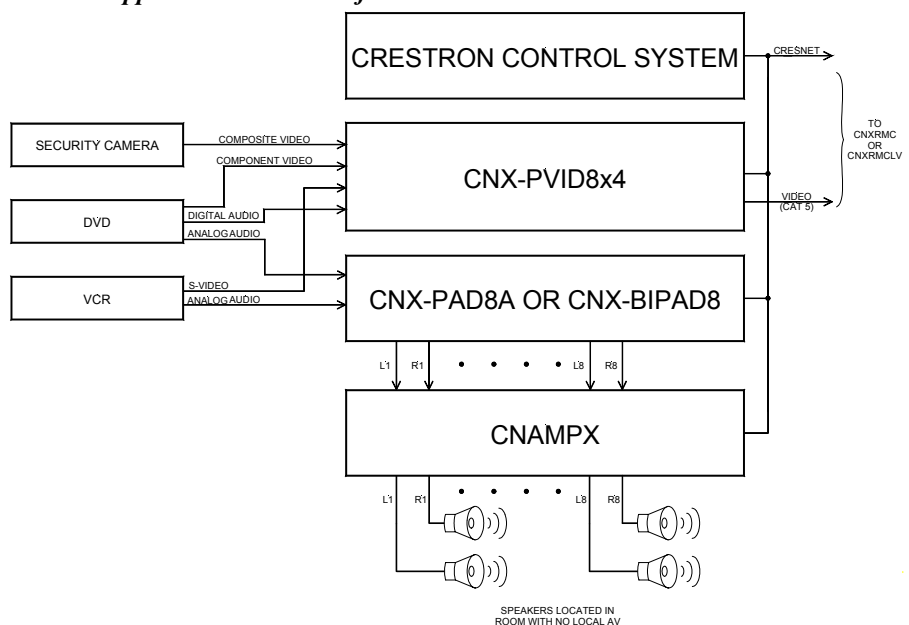

The Crestron Application Builder™ (Crestron AppBuilder) can be used to facilitate the programming portion of this system. However, due to the wiring constraints between the CNX-PVID8x4 and Crestron Room Solution Boxes, each type of video

source must connect to a specific group of input connectors, which is dependent on the hardware configuration chosen. Refer to "Hardware Configurations" on page 14 for specific connection details.

CNX-PVID8x4 used without Crestron Room Solution Box

In this system, the CNX-PVID8x4 has an incredible amount of flexibility with respect to making connections to all three types of video sources. For example, it is possible to have a composite source connected to INPUT 1, level 1 and an S-video source connected to INPUT 1, levels 2 and 3, simultaneously. However, the Crestron AppBuilder cannot be used for the programming portion of this kind of system. All programming is done entirely in SIMPL Windows.

Specifications

The following table provides a summary of specifications for the CNX-PVID8x4.

Specifications of the CNX-PVID8x4

SPECIFICATION	DETAILS
Power Requirements	40 Watts (1.67 Amp @ 24 VDC)
Default Net ID	41
Control System Update Files ^{1, 2, 3}	
2-Series Control System	Version 2.004.CUZ or later
CNMSX-AV/PRO	Version 5.14.02X.UPZ or later
CNRACKX-DP	Version 5.14.02W.UPZ or later
CEN/CN-TVAV	Version 5.12.63V.UPZ or later
ST-CP	Version 4.02.4S.UPZ or later
CNX-PVID8x4 Firmware ⁴	PVID_16.upg or later PVID_16.s19 or later
Rack space required	4U high; 1U wide
Video bandwidth	100 MHz
Crosstalk	> -60 dB
Environmental temperature range	41° to 104°F (5° to 40°C)
Humidity	10% to 90% RH (non-condensing)
Dimensions (without mounting ears)	Height: 6.97 in (17.70 cm) Width: 17.29 in (43.92 cm) Depth: 8.45 in (21.46 cm)
Weight	9.81 lb (4.45 kg)

1 The latest versions can be obtained from the Downloads | Software Updates section of the Crestron website (www.crestron.com). Refer to following NOTE.

2 Crestron 2-Series control systems include the AV2 and PRO2. Consult the latest Crestron Product Catalog for a complete list of 2-Series control systems.

3 Filenames for CNX and ST-CP update files have a UPZ extension. Files on the website may be .zip or self-extracting .exe files containing the .cuz or .upz file. All can be obtained from the Downloads section of the Crestron website. To avoid program problems, make sure you are using the update file with the correct suffix letter (e.g., S, V, W, X)

4 Refer to firmware upgrade release notes for applicability.

NOTE: Crestron software and any files on the website are for Authorized Crestron dealers and Crestron Authorized Independent Programmers (CAIP) only. New users may be required to register to obtain access to certain areas of the site (including the FTP site).

Physical Description

The CNX-PVID8x4 is housed in a black enclosure with labeling on the front and rear panels. LEDs on the front of the unit indicate the unit's status. All connections are made to the back of the unit. Refer to the following illustrations.

CNX-PVID8x4 Front View

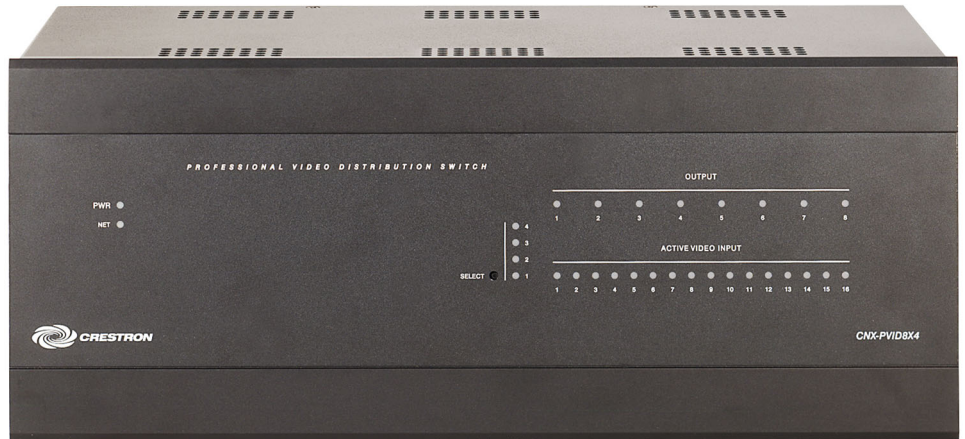

CNX-PVID8x4 Rear View

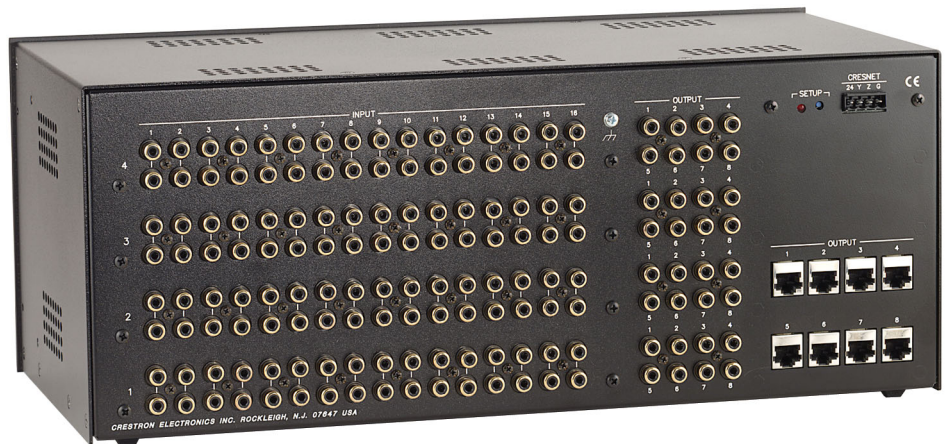

CNX-PVID8x4 Physical Views

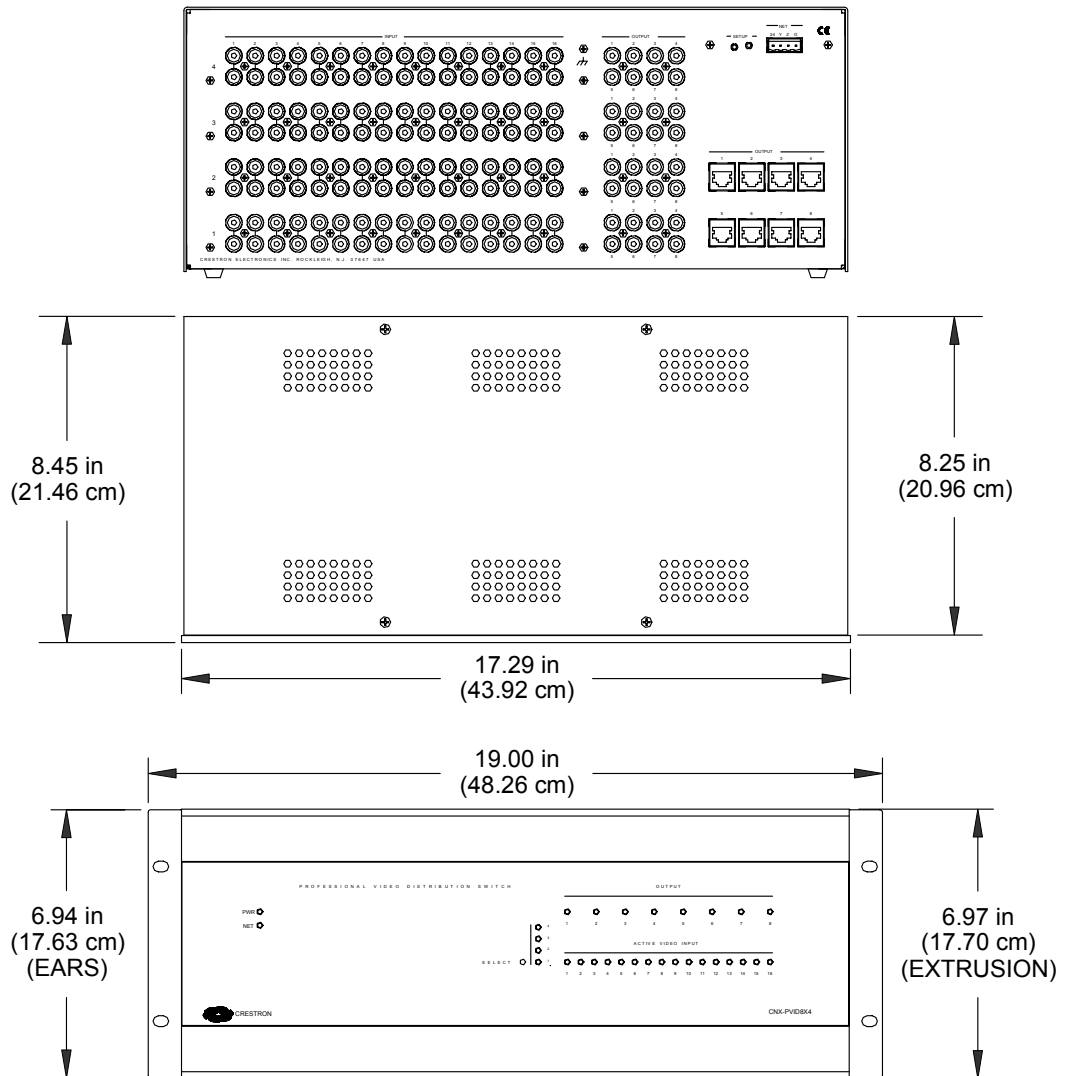

Two mounting ears are provided for rack mounting; four square rubber feet are provided for tabletop mounting or stacking. These feet are to be attached on the base of the unit for stability and to prevent slippage.

CNX-PVID8x4 Ports

All connections to the CNX-PVID8x4 are made through the ports on the rear panel. Refer to the following illustrations and descriptions.

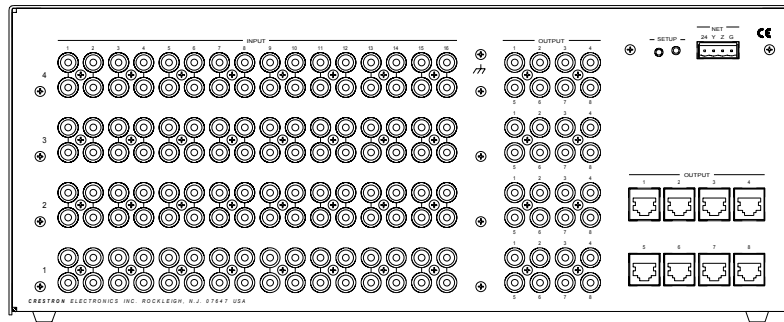
CNX-PVID8x4 Ports**INPUT 1 – 16 (Levels 1 – 4)**

There are four levels of 16 inputs, each input has two RCA jacks connected in parallel (one for video input, one for termination or loop-through), which is used to connect independent video sources to the CNX-PVID8x4. Each connector is supplied with RCA terminators (75 ohm). The terminators should remain attached unless the **INPUT** connectors of multiple units are connected (loop-through). Refer to "Signal Distribution to More than Eight Rooms" on page 19 for a description and illustration about loop-through. The last unit in the loop must have terminators installed.

All video inputs have a video sensor so that the power status of all components can be reported. Only inputs with sync can be reliably detected (composite or luminance).

OUTPUT (RCA Connectors)

There are four levels of eight RCA jacks (32 total) for single ended (local mode) video.

NOTE: The information on the OUTPUT RCA connectors and OUTPUT RJ-45 connectors are identical; they are not independently controllable.

OUTPUT (RJ-45 Connectors)

There are eight RJ-45 connectors for differential digital audio/video (CAT5 mode). The outputs are grouped into four pairs and correspond to the input levels as shown in the table after this paragraph. Use a standard CAT5 cable.

Pairing of RJ-45 OUTPUT Connector Pins with respect to the INPUT Levels

PAIRED PIN #	ASSOCIATED INPUT LEVEL
1 (+) and 2 (-)	1
3 (+) and 6 (-)	2
4 (+) and 5 (-)	3
7 (+) and 8 (-)	4

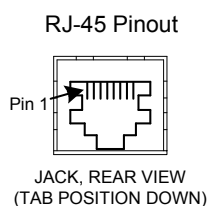

NOTE: For additional information on video connections over CAT5, refer to the latest version of the Crestron CAT5 Wiring Reference Guide (Doc. 6137) which is available from the Downloads | Product Manuals section of the Crestron website (www.crestron.com).

NET

This 4-pin terminal block connector is used to connect the CNX-PVID8x4 to the Cresnet[®] system. Refer to "Network Wiring" on page 8 for details.

CNX-PVID8x4 Indicators

There are 30 LED indicators located on the front panel of the CNX-PVID8x4, and one on the back panel. Refer to the following illustration and descriptions.

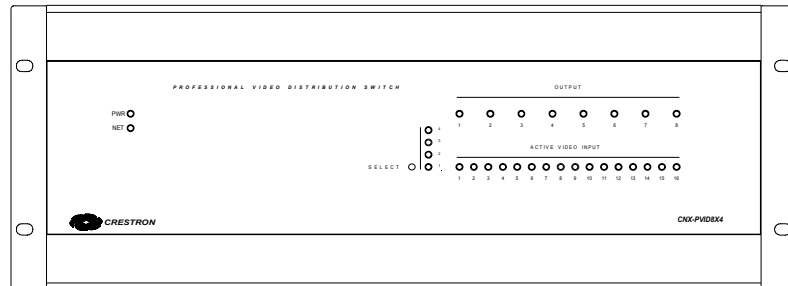
CNX-PVID8x4 Indicators**PWR (Power)**

This LED illuminates when 24 volts DC from the network is supplied to the CNX-PVID8x4.

NET

This LED illuminates when communication between the Cresnet system and the CNX-PVID8x4 is established (unit is polled on the network). Illumination indicates that the SIMPL Windows program currently loaded has a network device defined at the same Net ID as the CNX-PVID8x4.

SELECT 1 - 4

These LEDs illuminate when a switcher board (levels 1 through 4) is selected. Boards can be locally selected with a pushbutton. Refer to "CNX-PVID8x4 Pushbuttons" on this page for details.

OUTPUT 1 - 8

These eight LEDs illuminate to indicate that a source is routed via the respective port to the corresponding room.

ACTIVE VIDEO INPUT

These 16 video sync indicators illuminate to signify active inputs on the selected board (level).

NOTE: Only composite video and the "Y" S-video/component signal are reliably detected. If connections to the **INPUT** connectors are made as recommended by Crestron in "Hardware Configurations" on page 14, simply use level 1 for detection of the sync signals.

SETUP

This LED is the lone indicator on the back panel. The LED is intended for future use and is not defined at the time of printing.

CNX-PVID8x4 Pushbuttons

There are two pushbuttons on the CNX-PVID8x4 (one on the front panel and one on the back panel). The front panel **SELECT** pushbutton allows for local selection of the boards (levels 1 through 4). Four indicators are used as feedback. The rear panel **SETUP** pushbutton is for future use and is not defined at the time of printing.

Industry Compliance

As of the date of manufacture, the CNX-PVID8x4 has been tested and found to comply with specifications for CE marking and standards per EMC and Radiocommunications Compliance Labelling.



NOTE: This device complies with part 15 of the FCC rules. Operation is subject to the following two conditions: (1) these devices may not cause harmful interference, and (2) these devices must accept any interference received, including interference that may cause undesired operation.

Setup

Network Wiring

CAUTION: Use only Crestron power supplies for Crestron equipment. Failure to do so could cause equipment damage or void the Crestron warranty.

NOTE: When installing network wiring, refer to the latest revision of the wiring diagram(s) appropriate for your specific system configuration, available from the Downloads | Product Manuals | Wiring Diagrams section of the Crestron website (www.crestron.com).

When calculating the wire gauge for a particular Cresnet run, the length of the run and the power factor of each network unit to be connected must be taken into consideration. If Cresnet units are to be daisy-chained on the run, the power factor of each unit to be daisy-chained must be added together to determine the power factor of the entire chain. If the unit is a home-run from a Crestron system power supply network port, the power factor of that unit is the power factor of the entire run. The length of the run in feet and the power factor of the run should be used in the following resistance equation to calculate the value on the right side of the equation.

Resistance Equation

$$R < \frac{40,000}{L \times PF}$$

Where: R = Resistance (refer to table below). L = Length of run (or chain) in feet. PF = Power factor of entire run (or chain).

The required wire gauge should be chosen such that the resistance value is less than the value calculated in the resistance equation. Refer to the following table.

Wire Gauge Values

RESISTANCE (R)	WIRE GAUGE
4	16
6	18
10	20
15	22
13	Doubled CAT5
8.7	Tripled CAT5

NOTE: All network wiring must consist of two twisted-pairs. One twisted pair is the +24V conductor and the GND conductor and the other twisted pair is the Y conductor and the Z conductor.

NOTE: When daisy-chaining Cresnet units, strip the ends of the wires carefully to avoid nicking the conductors. Twist together the ends of the wires that share a pin on the network connector, and tin the twisted connection. Apply solder only to the ends of the twisted wires. Avoid tinning too far up the wires or the end becomes brittle. Insert the tinned connection into the Cresnet connector and tighten the retaining screw. Repeat the procedure for the other three conductors.

Identity Code

Every equipment and user interface within the network requires a unique identity code (Net ID). These codes are two-digit hexadecimal numbers from 03 to FE. The Net ID of each unit must match an ID code specified in the SIMPL Windows program. Refer to “Setting the Net ID in Device Settings” on page 22 for details of the SIMPL Windows procedure.

Refer to the note on page 31 for a definition of Viewport.

The Net ID of the CNX-PVID8x4 has been factory set to **41**. The Net IDs of multiple CNX-PVID8x4s in the same system must be unique. Net IDs are changed from a personal computer (PC) via the Crestron Viewport.

NOTE: For detailed information on establishing communication between the PC and control system, refer to “Communication Settings” on page 31. If communication cannot be established, refer to the “Troubleshooting Communications” section in the respective Operations Guide for the control system.

Complete the following steps to change the Net ID

1. Ensure that the CNX-PVID8x4 is the only device connected to the control system.
2. Open the Crestron Viewport.
3. From the Viewport menu, select **Functions | Set Network ID**. The software checks the baud rate and then opens the "Set Network ID" window.
4. In the "Set Network ID" window, select the CNX-PVID8x4 from the *Current Network Devices* text window.
5. Select the new Net ID for the CNX-PVID8x4 from the *Choose the new network ID for the selected device (Hex):* text box.

6. Click **Set ID** to initiate the change. This will display the "ID command has been sent" window.
7. In the "Command Complete" window, click **OK**.
8. In the *Current Network Devices* text window, verify the new Net ID code.
9. In the "Set Network ID" window, click **Close**.

NOTE: The new Net ID code may also be verified by selecting **Diagnostic | Report Network Devices** in the Viewport (alternately, select **F4**).

10. Repeat this procedure for each CNX-PVID8x4 to be added to the system.

Cabling and Jumpers

Out of the box, the CNX-PVID8x4 provides four 16x8 crosspoint boards that can be operated independently or in parallel. However, versatility was built into the unit. Depending on how the four boards are cabled and/or jumpered, the unit can be used in different hardware configurations. For example, cabling boards 1 and 3 conceptually eliminates level 3 (thus component sources are not allowed with this configuration) and extends level 1 with 16 composite-only connections. Furthermore, installation of the cable assembly and removal of jumpers splits level 3 (thus component sources are restricted to inputs 9 through 16) and extends level 1 with eight composite-only connections.

NOTE: Possible configurations and their respective applications when the CNX-PVID8x4 is connected to Crestron Room Solution Boxes are summarized in "Hardware Configurations" on page 14. Furthermore, cabling and jumper removal may prove useful in systems where the CNX-PVID8x4 does not connect to a Crestron Room Solution Box.

If the out-of-the-box configuration is desired, the following procedure, which defines how to install the cable and remove jumpers, need not be completed. If one of the other configurations is required, the only tools needed to complete this procedure are a #2 Phillips screwdriver and a grounding strap (grounded workstation).

CAUTION: The CNX-PVID8x4 contains ESD sensitive devices. Perform the following procedure while wearing a grounding strap that is properly grounded or on a grounded workstation to avoid damaging the unit.

NOTE: This procedure assumes that the CNX-PVID8x4 does not have rack ears attached and has yet to be connected to the network.

1. Place the CNX-PVID8x4 right side up on a flat surface.
2. Using a #2 Phillips screwdriver, remove the 16 cover screws from the top (four screws) and sides (six per side) of the CNX-PVID8x4.
3. Lift and remove the CNX-PVID8x4 top cover.
4. Use the supplied cable (15863) to connect board 1 (bottom board) to board 3, as shown in the following diagram.

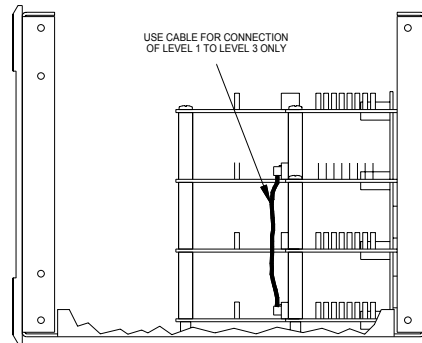
Location of Cable Connection (Side View of Unit)

5. If the desired application requires removal of the jumpers, remove the nine jumpers from level 3 (top board) only, as shown in the diagram after this step. Otherwise, skip this step and step 6.

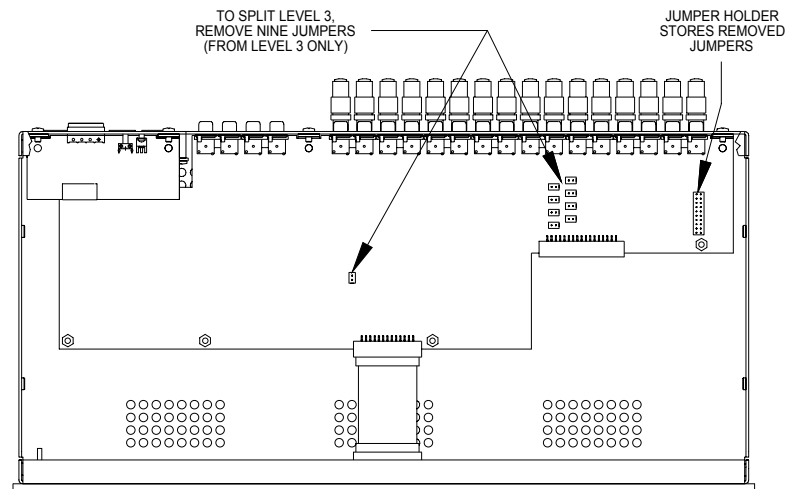
Location of Jumpers (Top View with Cover Removed)

NOTE: Eight of the nine jumpers are grouped together. Do not forget to remove the ninth jumper that is located separately from the other eight.

6. Store jumpers removed in step 5 on the jumper holder, as shown in the diagram that precedes this step.
7. Place the cover over the unit (observe proper orientation with respect to front and back panels) and secure with 16 cover screws.
8. Tighten screws to finger-tight then, using a #2 Phillips screwdriver, tighten an additional 1/8-turn.

Rack Mounting

WARNING: To prevent bodily injury when mounting or servicing this unit in a rack, take special precautions to ensure that the system remains stable. The following guidelines are provided to ensure user safety.

- The unit should be mounted at the bottom of the rack if it is the only unit in the rack.

- When mounting this unit in a partially filled rack, load the rack from the bottom to the top with the heaviest component at the bottom of the rack.
- If the rack is provided with stabilizing devices, install the stabilizers before mounting or servicing the units in the rack.

NOTE: If rack mounting is not required, rubber feet are provided for tabletop mounting or stacking. Apply the feet near the corner edges on the underside of the unit. Refer to "Stacking" on page 12 for details.

NOTE: Reliable grounding of rack-mounted equipment should be maintained. Particular attention should be given to supply connections other than direct connections to the branch circuit (e.g., use of power strips).

Two "ears" are provided with the CNX-PVID8x4 so that the unit can be rack mounted. These ears must be installed prior to mounting. Complete the following procedure to attach ears to the CNX-PVID8x4. The only tool required for this procedure is a #2 Phillips screwdriver.

1. Position a rack ear so that its drilled holes align with the four vacated holes located on one side of the CNX-PVID8x4.
2. Use four screws (supplied, #6-32, 3/8"L) to secure the ear to the CNX-PVID8x4, as shown in the following diagram.

Ear Attachment for Rack Mounting (Side View of Unit)

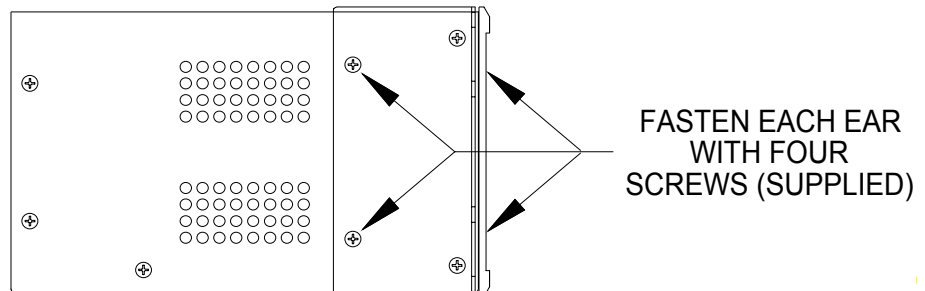

3. Tighten screws to finger-tight then, using a #2 Phillips screwdriver, tighten an additional 1/8-turn.
4. Repeat procedure (steps 1 and 2) to attach ear to the other side.
5. If the rear panel of the CNX-PVID8x4 is accessible when mounted in the rack, install the CNX-PVID8x4. If the rear panel is NOT accessible, perform the hookup procedure before rack installation.

Stacking

Four "feet" are provided with the CNX-PVID8x4 so that if the unit is not rack mounted, the rubber feet can provide stability when the unit is placed on a flat surface or stacked. These feet should be attached prior to the hookup procedure. Refer to the following illustration for placement of the feet.

Feet Location (Bottom View of Unit)

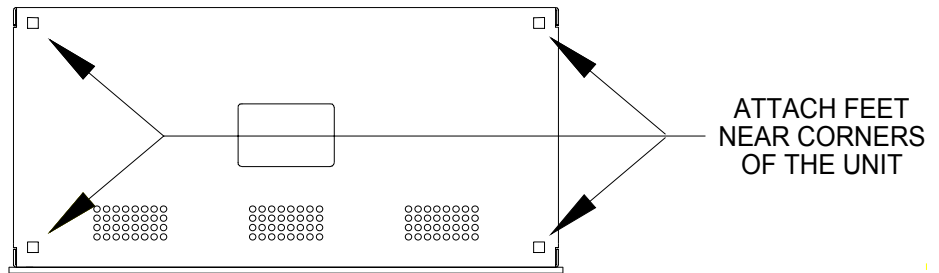

Hardware Hookup

Refer to the hookup diagram after this paragraph. Other than making the power connection last, complete the connections in any order.

NOTE: For specific details regarding input connections, refer to "Hardware Configurations" on page 14 if the CNX-PVID8x4 connects to Crestron Room Solution Boxes within the system.

NOTE: Refer to "Network Wiring" on page 8 when making connections to the port labeled CRESNET.

Hookup Connections for the CNX-PVID8x4

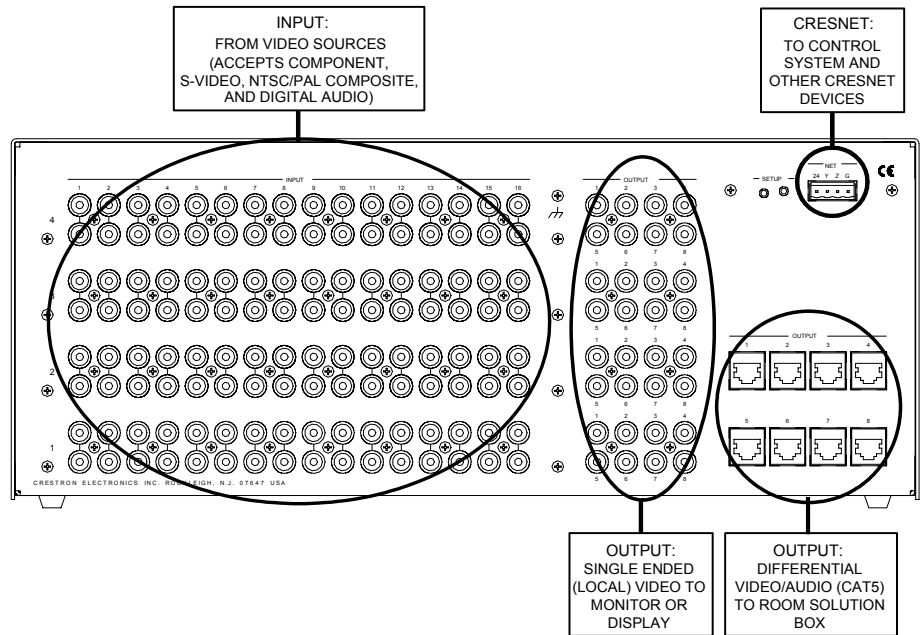

Hardware Configurations

NOTE: The hardware configurations described in the following sections only apply to systems where the CNX-PVID8x4 connects to Crestron Room Solution Boxes. The Crestron AppBuilder can generate a program that fits into one of these configurations.

The CNX-PVID8x4 is constructed with four crosspoint boards; each implements a 16x8x1 matrix. The physical boards are labeled on the back of the unit as "levels" 1, 2, 3, and 4 from bottom to top. Component sources connect to levels 1 through 3 per input (connect Y to level 1, P_b to level 2, and P_r to level 3). S-video sources use levels 1 and 2 per input (connect Y to level 1 and C to level 2). Composite sources should connect to level 1 only (including level 3 extensions of level 1 when boards 1 and 3 are connected via the cable assembly). Digital audio sources connect to level 4. Refer to the table after this paragraph for a tabulation of the relationship between input levels and audio/video formats.

Relationship of Audio and Video Formats to Input Levels

VIDEO FORMAT LEVEL	COMPONENT (connects to three levels)	S-VIDEO (connects to two levels)	COMPOSITE (connects to one level*)	DIGITAL AUDIO (connects to one level)
4	not connected	not connected	not connected	digital audio
3	P _r	not connected	not connected*	not connected
2	P _b	C	not connected	not connected
1	Y	Y	COMP	not connected

* Composite sources can physically connect to level 3 when boards 1 & 3 are connected via the cable assembly.

Depending on how the internal boards are cabled/jumpered, the unit can be used in different configurations (each is discussed in the following subsections). Refer to the following flowchart to determine which configuration to use (based on the source types in the system).

NOTE: Crestron recommends the out-of-the-box configuration, because it allows for the distribution of a large number of sources with the greatest flexibility and there is no need to open the unit. The other configurations permit a greater number of sources, but are not as flexible. The other configurations also require cabling of boards and possibly the removal of jumpers.

Flowchart: Determine the Configuration

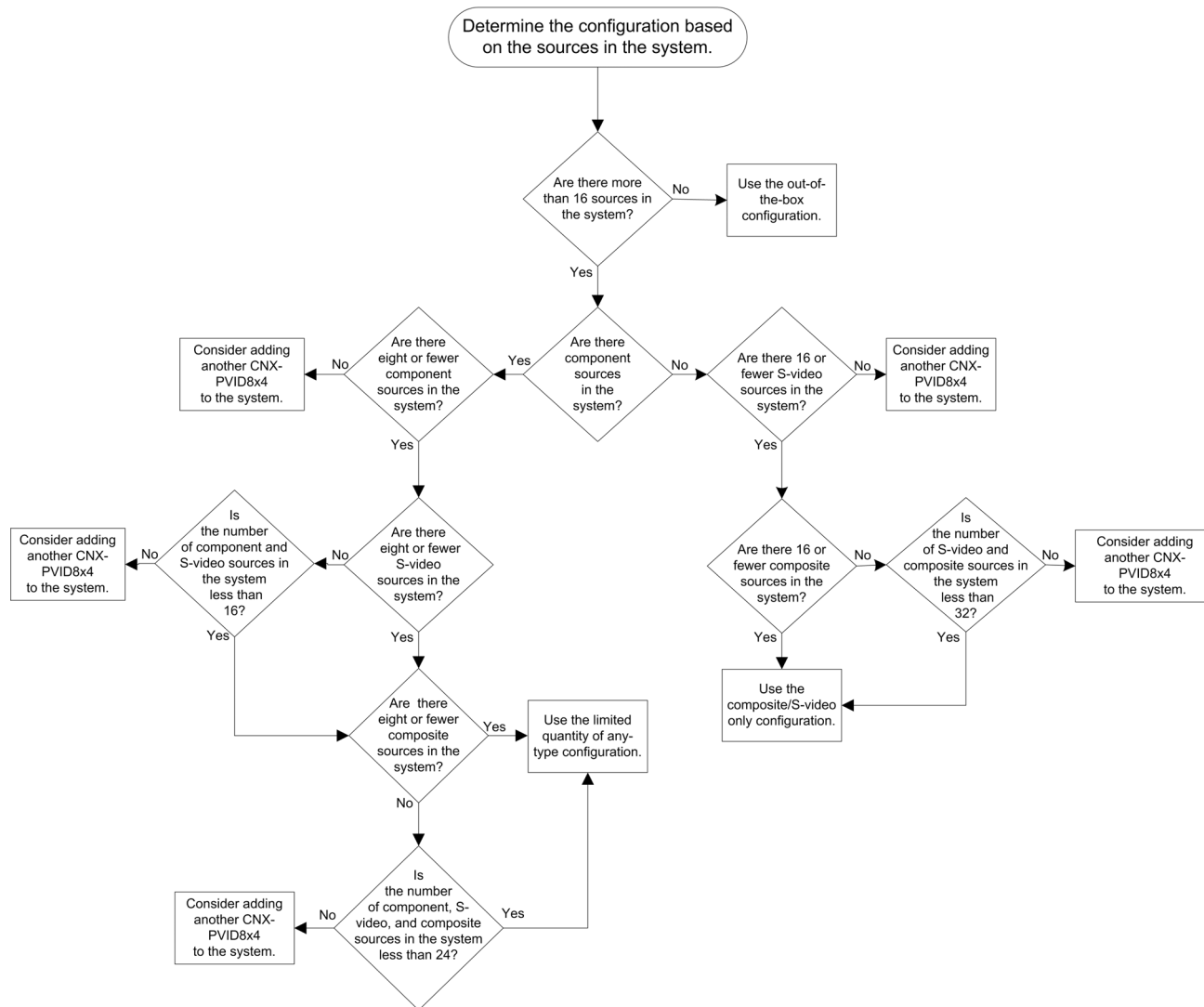

Out-of-the-Box Configuration

AKA: 16 Sources of Any Type (Video, S-Video, Component)

This configuration is aptly named, because the internal jumpers are intact, as shipped, and the supplied cable assembly is not used. Therefore, the unit is ready for immediate use and is capable of distributing a combination of up to 16 sources of **any type**. The built-in versatility of this configuration makes it the most popular and easiest to use.

NOTE: Installers **only** need to consider another configuration if the system consists of more than 16 sources.

The illustration after this paragraph provides a visual depiction of a system that utilizes the CNX-PVID8x4 and contains a combination of 16 or fewer composite, S-video, and component sources. Some of the sources also include digital audio. Notice that each input (labeled 1 through 16) can connect to a single source. The sequence of video signal type is irrelevant. Levels 1 through 4 are always switched together.

Cabling and Jumpering Internal Boards:

Cable between level 1 and level 3 is not attached.

Nine jumpers remain in their original location (no jumpers on the jumper holder).

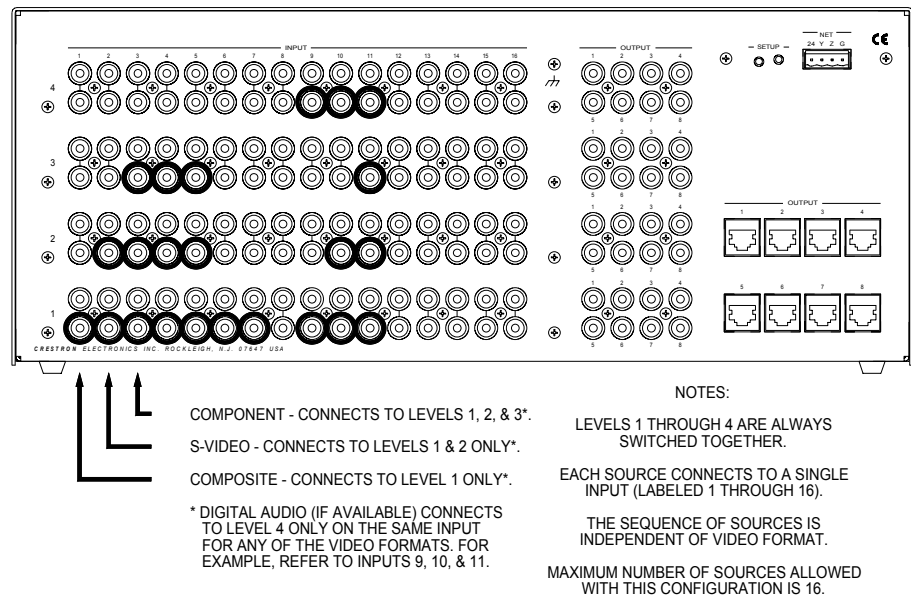
Illustration of Out-of-the-Box Configuration**Composite/S-Video Only Configuration**

AKA: 16 Video & Up to 16 S-Video or Video Sources

NOTE: Dealing with a system that contains more than 16 sources? This configuration may be preferred as long as the system does not contain component video.

To achieve this configuration, the unit must be opened and the cable assembly attached. Refer to "Cabling and Jumpers" on page 8 for details. The internal jumpers remain intact.

Conditions of this configuration; please read carefully!

This configuration allows for the greatest number of sources, 32. However, those sources can only be composite (up to 32, when there is no S-video) and S-video (up to 16, maximum). The illustration after this paragraph provides a visual depiction of a system that utilizes the CNX-PVID8x4 in the composite/S-video only configuration. Some of the sources also include digital audio. Notice that S-video sources can only be connected to input 1 through 16 (connect Y to level 1 and C to level 2). Installation of the cable assembly conceptually eliminates level 3 (thus component sources are not allowed with this configuration) and extends level 1 with 16 composite-only connections. Of course, if there are fewer than 16 S-video sources in the system, the number of composite sources can increase as long as the total number of composite and S-video sources does not exceed 32.

NOTE: The composite sources connected to level 3 are switchable to the output on level 1.

Cabling and Jumpering Internal Boards:

Cable between level 1 and level 3 is in place.

Nine jumpers remain in their original location (no jumpers on the jumper holder).

Illustration of Composite/S-Video Only Configuration

PHYSICAL CONNECTIONS:

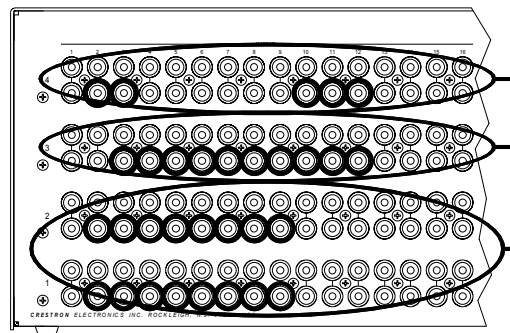

DIGITAL AUDIO (IF AVAILABLE): PHYSICALLY CONNECTS TO LEVEL 4 AND IS SWITCHED WITH LEVELS 1&2 OR LEVEL 3, BUT NOT LEVELS 1,2,&3 TOGETHER.

COMPOSITE SOURCES*: PHYSICALLY CONNECT TO LEVEL 3 (INPUTS 1 THROUGH 16), BUT ARE LOGICALLY AN EXTENSION OF LEVEL 1.

S-VIDEO SOURCES: PHYSICALLY CONNECT TO LEVELS 1 & 2 (INPUTS 1 THROUGH 16) ONLY.

*COMPOSITE SOURCES CAN CONNECT TO LEVEL 1 (WHEN THERE ARE FEWER THAN 16 S-VIDEO SOURCES). HOWEVER, THE TOTAL NUMBER OF COMPOSITE AND S-VIDEO SOURCES CANNOT EXCEED 32.

REFER TO THE LOGICAL DEPICTION (SHOWN BELOW) OF THE PHYSICAL CONNECTIONS (SHOWN ABOVE).

LOGICAL DEPICTION:

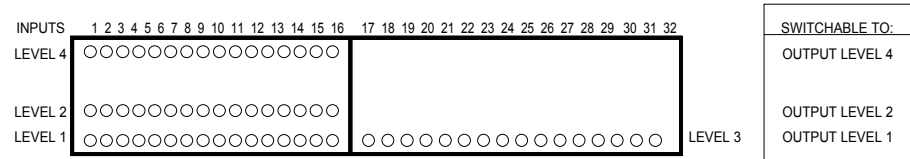

SWITCHABLE TO:
OUTPUT LEVEL 4
OUTPUT LEVEL 2
OUTPUT LEVEL 1

UP TO 16 S-VIDEO SOURCES ARE PERMITTED

NOTE: WHEN THERE ARE FEWER THAN 16 S-VIDEO SOURCES, COMPOSITE SOURCES CAN CONNECT TO LEVEL 1)

16 (OR MORE) COMPOSITE SOURCES* ARE PERMITTED.

NOTE: THE LABELING OF INPUTS 17 THROUGH 32 BECOMES USEFUL WHEN PROGRAMMING.

NOTE: DIGITAL AUDIO CAN ONLY BE DISTRIBUTED FOR A TOTAL OF 16 SOURCES. IF DIGITAL AUDIO IS DISTRIBUTED WITH THE S-VIDEO DEVICE CONNECTED TO INPUT 1, INPUT 17 WOULD BE PROHIBITED FROM USING LEVEL 4 FOR DIGITAL AUDIO (AND VICE VERSA). THE SAME IS TRUE FOR PAIRED INPUTS 2&18, 3&19, UP TO 16&32. HOWEVER, WHEN PROGRAMMING DIGITAL AUDIO, USE THE INPUT NUMBER LESS THAN 16.

Limited Quantity of Any-Type Configuration

AKA: 8 Video, Up to 8 S-Video/Video, and Up to 8 Component/S-Video/Video Sources

NOTE: Dealing with a system that contains more than 16 sources? This configuration may be preferred as long as the system does not contain more than eight component video sources.

This configuration somewhat mimics the out-of-the-box configuration, but there are differences. The first difference is that jumpers need to be removed and the cable assembly must be attached. Refer to "Cabling and Jumpers" on page 8 for details. Secondly, even though the total number of mixed sources allowed in this configuration is greater, it does not permit more than eight component sources at any time.

Conditions of this configuration; please read carefully!

This configuration allows for up to 24 sources. However, those sources cannot exceed more than eight component, more than 16 S-video (assuming no component sources), more than 24 composite (when there is no S-video and no component). The illustration after this paragraph provides a visual depiction of a system that utilizes the limited quantity of any-type configuration. Some of the sources also include digital audio. Notice that component sources can only be connected to input 9 through 16 (levels 1, 2, & 3) and that S-video sources can only connect to input 1 through 8 (levels 1 and 2). Installation of the cable assembly and removal of jumpers splits level 3 (thus component sources are restricted to inputs 9 through 16) and extends level 1 with eight composite-only connections. Of course, if there are fewer than eight component (or eight S-video) sources in the system, the number of S-video and/or composite sources can increase as long as the total number of sources does not exceed 24.

Illustration of Limited Any-Type Configuration

Cabling and Jumpering Internal Boards:

Cable between level 1 and level 3 is in place.

Nine jumpers are removed from their original location and stored on the jumper holder.

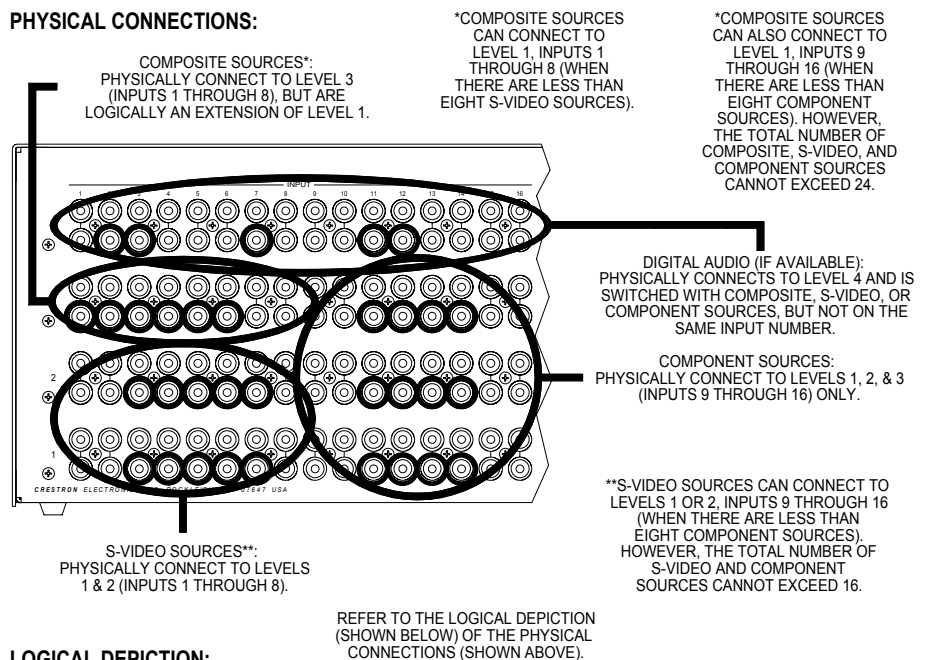

LOGICAL DEPICTION:

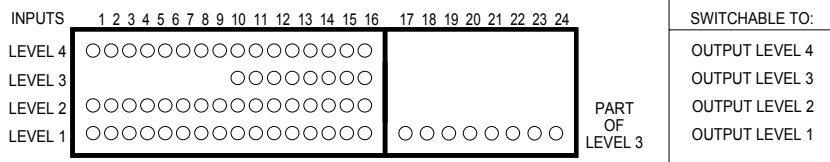

EIGHT (OR MORE) S-VIDEO SOURCES** ARE PERMITTED.

UP TO EIGHT COMPONENT SOURCES ARE PERMITTED.

EIGHT (OR MORE) COMPOSITE SOURCES* ARE PERMITTED.

NOTE: THE LABELING OF INPUTS 17 THROUGH 24 BECOMES USEFUL WHEN PROGRAMMING.

NOTE: DIGITAL AUDIO CAN ONLY BE DISTRIBUTED FOR A TOTAL OF 16 SOURCES. IF DIGITAL AUDIO IS DISTRIBUTED WITH THE S-VIDEO DEVICE CONNECTED TO INPUT 1, INPUT 17 WOULD BE PROHIBITED FROM USING LEVEL 4 FOR DIGITAL AUDIO (AND VICE VERSA).

THE SAME IS TRUE FOR PAIRED INPUTS 2&18, 3&19, UP TO 8&24. HOWEVER, WHEN PROGRAMMING DIGITAL AUDIO, USE THE INPUT NUMBER LESS THAN 8.

Signal Distribution to More than Eight Rooms

Each CNX-PVID8x4 is capable of distributing video to eight rooms, maximum. It is possible to expand distribution to more rooms, if additional CNX-PVID8x4s are introduced to the system. Crestron recommends a maximum of four CNX-PVID8x4s per system. Therefore, video can be distributed to a maximum of 32 rooms. Each input to the unit has two RCA jacks connected in parallel (per level). Use one of the jacks for loop-through, as shown in the illustration after this paragraph.

NOTE: The last unit in the loop-through connection must have terminators installed.

Video Distribution Expansion with Additional CNX-PVID8x4s

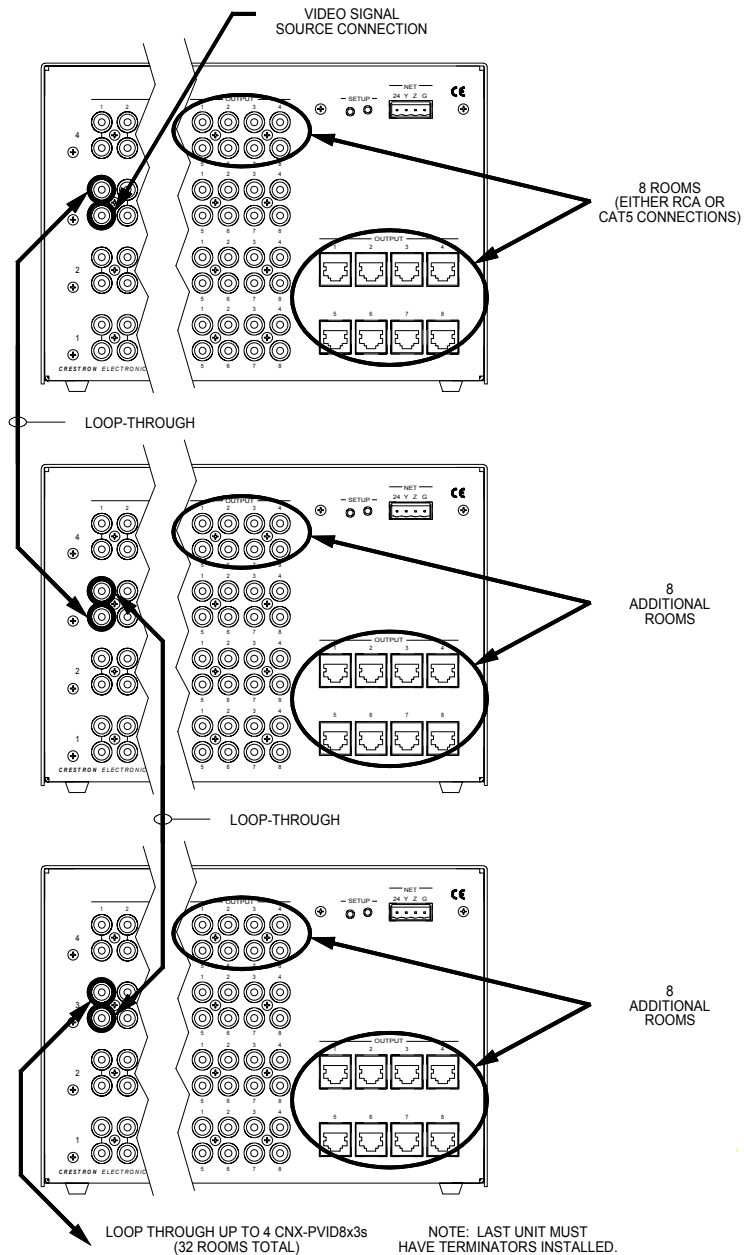

Programming Software

Have a question or comment about Crestron software?

Answers to frequently asked questions (FAQs) can be viewed in the Online Help section of the Crestron website (www.crestron.com). To post your own question or view questions you have submitted to Crestron's True Blue Support, log in at <http://support.crestron.com>. First-time users will need to establish a user account.

Setup is easy thanks to Crestron's Windows®-based programming software. The Crestron Application Builder™ (AppBuilder) creates a complete project, with no special programming required. Crestron AppBuilder completes all necessary programming for a base system including all touchpanel screens and the control system program. Once Crestron AppBuilder creates the project, the system interfaces and program logic can be customized. It can easily be modified with Crestron development tools (i.e., SIMPL Windows and Crestron VisionTools® Pro-e (VT Pro-e) software packages).

The program output of Crestron AppBuilder is a SIMPL Windows program with much of the functionality encapsulated in macros. Therefore, extending the capabilities of the system is very easy. Crestron AppBuilder and SIMPL Windows are intended for users with different levels of programming knowledge. Crestron AppBuilder is easier to use for the beginning programmer, and much faster for all programmers. However, it does not allow the degree of control and flexibility that SIMPL Windows does. Of course, one can initiate programming using the easiest method (Crestron AppBuilder) and use advanced techniques that are available from SIMPL Windows to customize the job.

Crestron AppBuilder comes with templates for all supported interfaces. If a user wishes to create a touchpanel project using templates with a different look-and-feel, this can be accomplished by making a custom template. This custom template can then be used by Crestron AppBuilder to create the final project files to be loaded into the panels. Alternatively, VT Pro-e can be used to tweak projects created with the Crestron AppBuilder or develop original touchpanel screen designs.

Earliest Version Software Requirements for the PC

NOTE: Crestron recommends that you use the latest software to take advantage of the most recently released features. The latest software is available from the Downloads | Software Updates section of the Crestron website (www.crestron.com).

The following are recommended software version requirements for the PC:

- (Optional) Crestron Application Builder version 1.2.5 or later. Requires SIMPL Windows.
- SIMPL Windows version 2.00 or later. Requires SIMPL+ Cross Compiler version 1.1.
- Crestron Database version 15.0 or later. Required by SIMPL Windows.

The easiest method of programming, but does not offer as much flexibility as SIMPL Windows.

Programming with Crestron AppBuilder

Crestron AppBuilder offers automatic programming for such residential and commercial applications as audio distribution, home theater, and video conferencing. The interface of this tool guides you through a few basic steps for designating rooms and specifying the control system, touchpanels, devices, and functionality. Crestron AppBuilder then programs the system, including all touchpanel projects and control system logic.

Crestron AppBuilder is fully integrated with Crestron's suite of software development tools, including SIMPL Windows, VT Pro-e, and the Crestron Database. Crestron AppBuilder accesses these tools behind the scenes, enabling you to easily create robust systems.

Programming with SIMPL Windows

NOTE: The following are acceptable file extensions for programs that include a CNX-PVID8x4, developed for specific control system types:

.smw	<i>projectname</i> .smw (source file)
.spz	<i>projectname</i> .spz (compiled file for 2-series)
.bin	<i>projectname</i> .bin (compiled file for CNX generation)
.csz	<i>projectname</i> .csz (compiled file for CNX generation with SIMPL+)
.ush	<i>projectname</i> .ush (compiled file for CNX generation with SIMPL+ header file)
.usp	<i>projectname</i> .usp (source code module for SIMPL+)

SIMPL Windows is Crestron's software for programming Crestron control systems. It provides a well-designed graphical environment with a number of workspaces (i.e., windows) in which a programmer can select, configure, program, test, and monitor a Crestron control system. SIMPL Windows offers drag and drop functionality in a familiar Windows® environment.

NOTE: The following descriptions assume that the reader has knowledge of SIMPL Windows. If not, refer to the extensive help information provided with the software.

NOTE: In the following description, the PRO2 control system is used.

This section describes a sample SIMPL Windows program that includes a CNX-PVID8x4.

Configuration Manager is where programmers “build” a Crestron control system by selecting hardware from the *Device Library*. In Configuration Manager, drag the PRO2 from the Control Systems folder of the *Device Library* and drop it in the upper pane of the *System Views*. The PRO2 with its associated communication ports is displayed in the *System Views* upper pane.

PRO2 System View

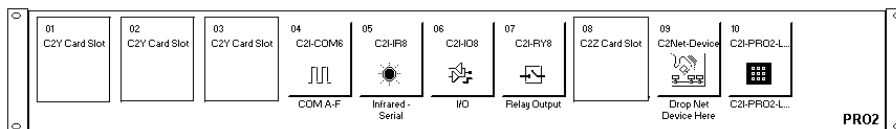

The *System Views* lower pane displays the PRO2 system tree (refer to following graphic). This tree can be expanded to display and configure the communications ports.

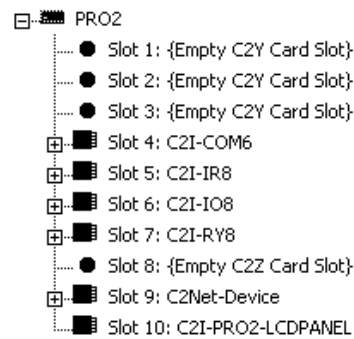
Expanded PRO2 System Tree**C2Net Device Slot in Configuration Manager**

To incorporate a CNX-PVID8x4 into the system, drag the CNX-PVID8x4 from the Cresnet Control Modules | Cresnet Video Modules folder of the *Device Library* and drop it in *System Views*. The PRO2 system tree displays the CNX-PVID8x4 in Slot 9, with a default Net ID of **41** as shown in the following illustration.

NOTE: SIMPL Windows provides three separate symbols for the CNX-PVID8x4, each one intended for a particular system configuration. Select the appropriate one to be placed in *System Views*. Refer to “CNX-PVID8x4 Symbols” on page 23 for details about each symbol.

NOTE: The first CNX-PVID8x4 in a system is preset with a Net ID of **41** when its symbol is dragged into the upper pane of *System Views*. Additional units are assigned different Net ID numbers as they are added.

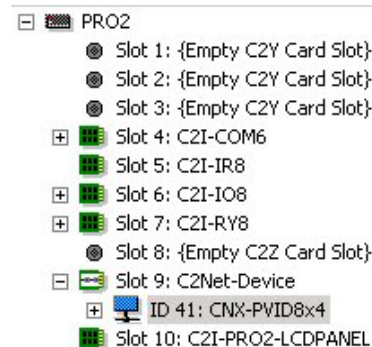
C2Net Device, Slot 9**Setting the Net ID in Device Settings**

Double-click the CNX-PVID8X4 icon to open the “Device Settings” window. This window displays the CNX-PVID8X4 device information. If necessary, select the *Net ID* tab to change the unit’s Net ID, as shown in the following figure.

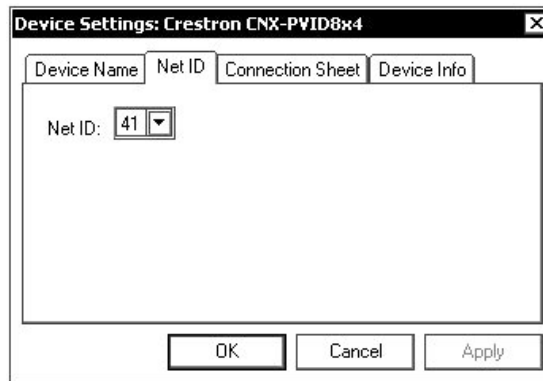
CNX-PVID8x4- “Device Settings” Window

NOTE: SIMPL Windows automatically changes Net ID values of a device added to a program if a duplicate device or a device with the same default Net ID already exists in the program. Always ensure that the hardware and software settings of the Net ID match. For Net ID hardware setting details, refer to “Identity Code” on page 9.

CNX-PVID8x4 Symbols

The inputs to the CNX-PVID8x4 symbol require the analog equivalent (typically 1 through 16, but could go up to 32) so that the video source physically connected to a given input can be switched to the specified output. In SIMPL Windows, the following Analog Initialize logic symbol (decimal format) should be used to provide these analog inputs.

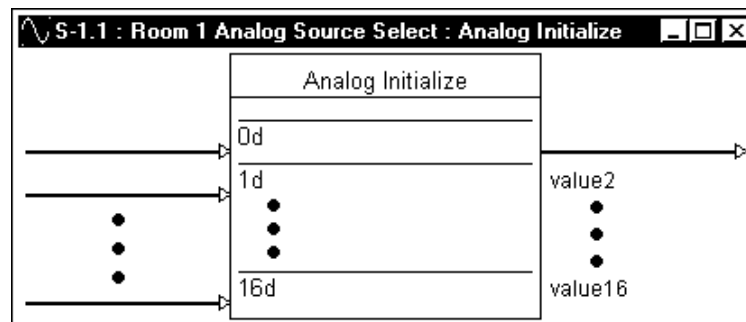
Detail View of the Analog Initialize Symbol

NOTE: The "0d" indicates no source.

Depending on how the four boards of the CNX-PVID8x4 are cabled and/or jumpered, the unit can be used in different hardware configurations. The diagrams in the next three sections show three CNX-PVID8x4 symbol designations that are available in SIMPL Windows. A table accompanies each diagram and lists the inputs and their functional descriptions.

Symbol Designation: CNX-PVID8x4

There is no cabling of boards or jumper removal for this symbol designation.

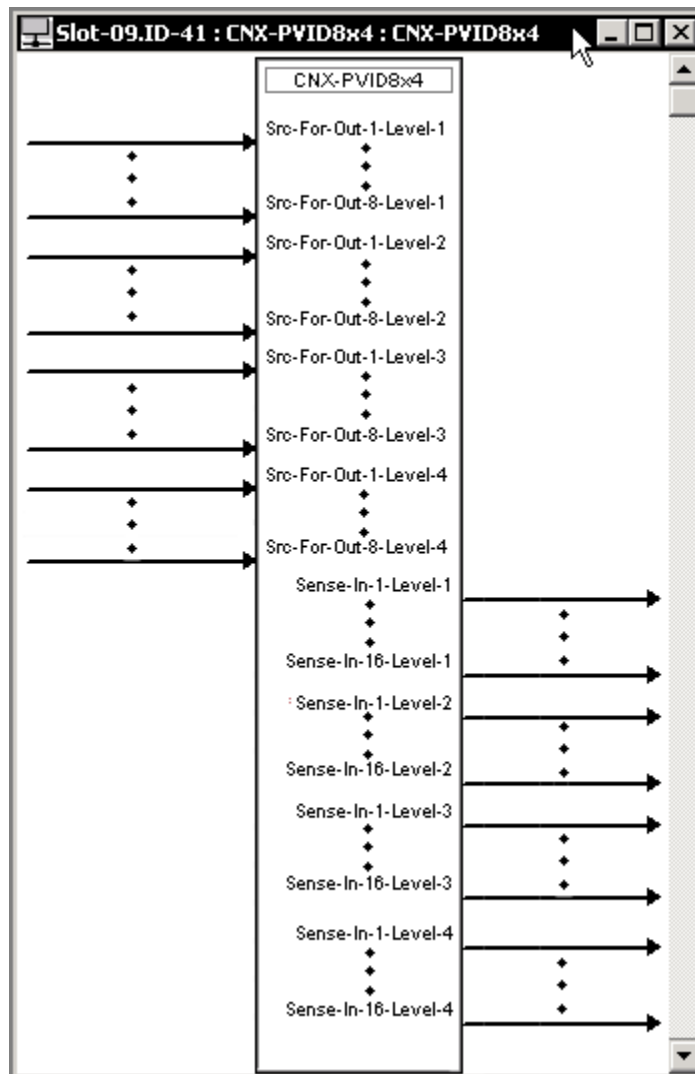
Detail View of the CNX-PVID8x4 Symbol*CNX-PVID8x4 Symbol Input Descriptions*

INPUT(S)	FUNCTION(S)
Src-For-Out-1-Level-1 through Src-For-Out-8-Level-1	Provide the analog equivalent (1 through 16) via the Analog Initialize symbol (decimal format) on this line so that the video source connected to the given input (on level 1) can be switched to the specified output on level 1.
Src-For-Out-1-Level-2 through Src-For-Out-8-Level-2	Provide the analog equivalent (1 through 16) via the Analog Initialize symbol (decimal format) on this line so that the video source connected to the given input (on level 2) can be switched to the specified output on level 2.
Src-For-Out-1-Level-3 through Src-For-Out-8-Level-3	Provide the analog equivalent (1 through 16) via the Analog Initialize symbol (decimal format) on this line so that the video source connected to the given input (on level 3) can be switched to the specified output on level 3.
Src-For-Out-1-Level-4 through Src-For-Out-8-Level-4	Provide the analog equivalent (1 through 16) via the Analog Initialize symbol (decimal format) on this line so that the video source connected to the given input (on level 4) can be switched to the specified output on level 4.

CNX-PVID8x4 Symbol Digital Output Descriptions

OUTPUT(S)	FUNCTION(S)
Sense-in-1-Level-1 through Sense-in-16-Level-1	High if a video signal is detected on the specific input (1 – 16) on level 1; otherwise, 0 (zero).
Sense-in-1-Level-2 through Sense-in-16-Level-2	High if a video signal is detected on the specific input (1 – 16) on level 2; otherwise, 0 (zero).
Sense-in-1-Level-3 through Sense-in-16-Level-3	High if a video signal is detected on the specific input (1 – 16) on level 3; otherwise, 0 (zero).
Sense-in-1- Level-4 through Sense-in-16-Level-4	High if a video signal is detected on the specific input (1 – 16) on level 4; otherwise, 0 (zero).

This symbol designation allows the programmer to attach inputs and outputs to the CNX-PVID8x4 when it is configured as four independent levels (16 input to eight outputs). On each level, the 16 inputs can be switched to any of the eight outputs on the same level.

DEPICTION OF LEVELS ON BACK OF UNIT:

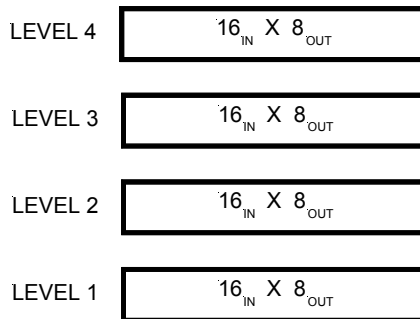

DEPICTION OF SYMBOL IN SIMPL WINDOWS:

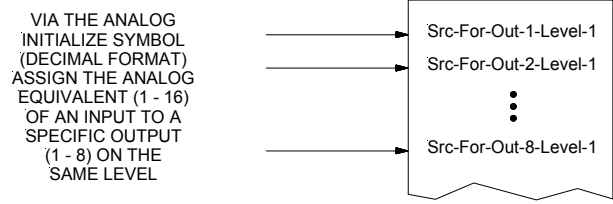

Symbol Designation: CNX-PVID8x4J13

For this symbol designation, level 3 is connected to level 1 with the supplied cable. This is the equivalent of extending level 1 with 16 additional inputs.

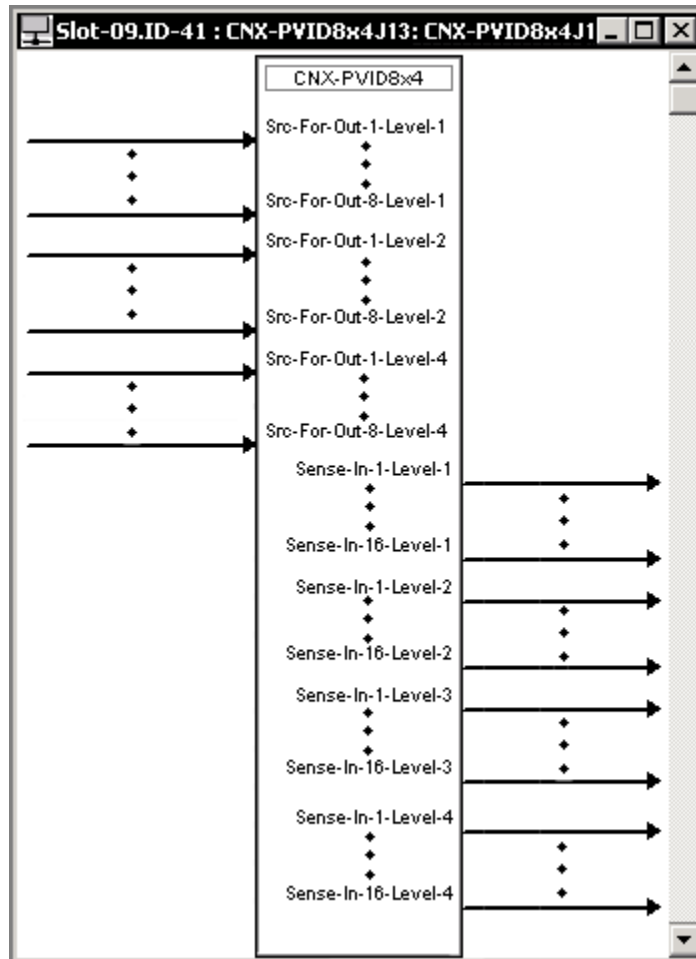
Detail View of the CNX-PVID8x4J13 Symbol**CNX-PVID8x4J13 Symbol Input Descriptions**

INPUT(S)	FUNCTION(S)
Src-For-Out-1-Level-1 through Src-For-Out-8-Level-1	Provide the analog equivalent (1 through 32) via the Analog Initialize symbol (decimal format) on this line so that the video source connected to the given input (on level 1, including the extension from level 3) can be switched to the specified output on level 1.
Src-For-Out-1-Level-2 through Src-For-Out-8-Level-2	Provide the analog equivalent (1 through 16) via the Analog Initialize symbol (decimal format) on this line so that the video source connected to the given input (on level 2) can be switched to the specified output on level 2.
Src-For-Out-1-Level-4 through Src-For-Out-8-Level-4	Provide the analog equivalent (1 through 16) via the Analog Initialize symbol (decimal format) on this line so that the video source connected to the given input (on level 4) can be switched to the specified output on level 4.

CNX-PVID8x4J13 Symbol Digital Output Descriptions

OUTPUT(S)	FUNCTION(S)
Sense-in-1-Level-1 through Sense-in-16-Level-1	High if a video signal is detected on the specific input (1 – 16) on level 1 (including extension from level 3); otherwise, 0 (zero).
Sense-in-1-Level-2 through Sense-in-16-Level-2	High if a video signal is detected on the specific input (1 – 16) on level 2; otherwise, 0 (zero).
Sense-in-1-Level-3 through Sense-in-16-Level-3	Identical to those output signals on Sense-In-1-Level-1 through Sense-In16-Level-1.
Sense-in-1- Level-4 through Sense-in-16-Level-4	High if a video signal is detected on the specific input (1 – 16) on level 4; otherwise, 0 (zero).

This symbol allows the programmer to attach inputs and outputs to the CNX-PVID8x4 when it is configured as three levels (one with 32 inputs to eight outputs and the other two with 16 inputs to eight outputs). On level 1, the 32 inputs can be switched to any of the eight outputs on the same level. On each other level, the 16 inputs can be switched to any of the eight outputs on the same level.

DEPICTION OF LEVELS ON BACK OF UNIT:

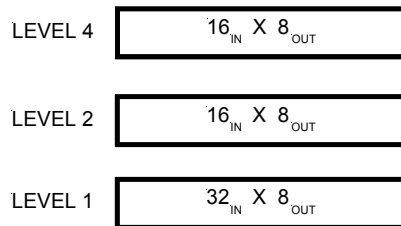

DEPICTION OF SYMBOL IN SIMPL WINDOWS:

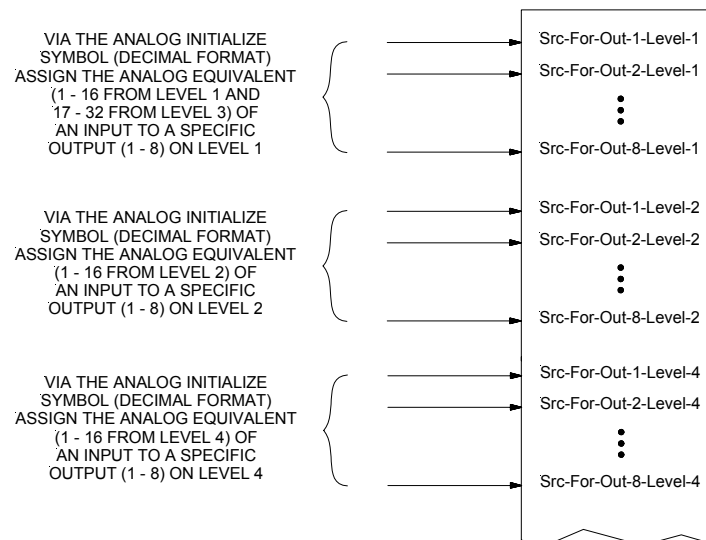

Symbol Designation: CNX-PVID8x4J13S

For this symbol designation, level 3 is divided in half by removing jumpers. Furthermore, half of level 3 (inputs 1 through 8) is connected to level 1 with the supplied cable. This is the equivalent of extending level 1 with eight additional inputs and still allowing for connections to component video sources.

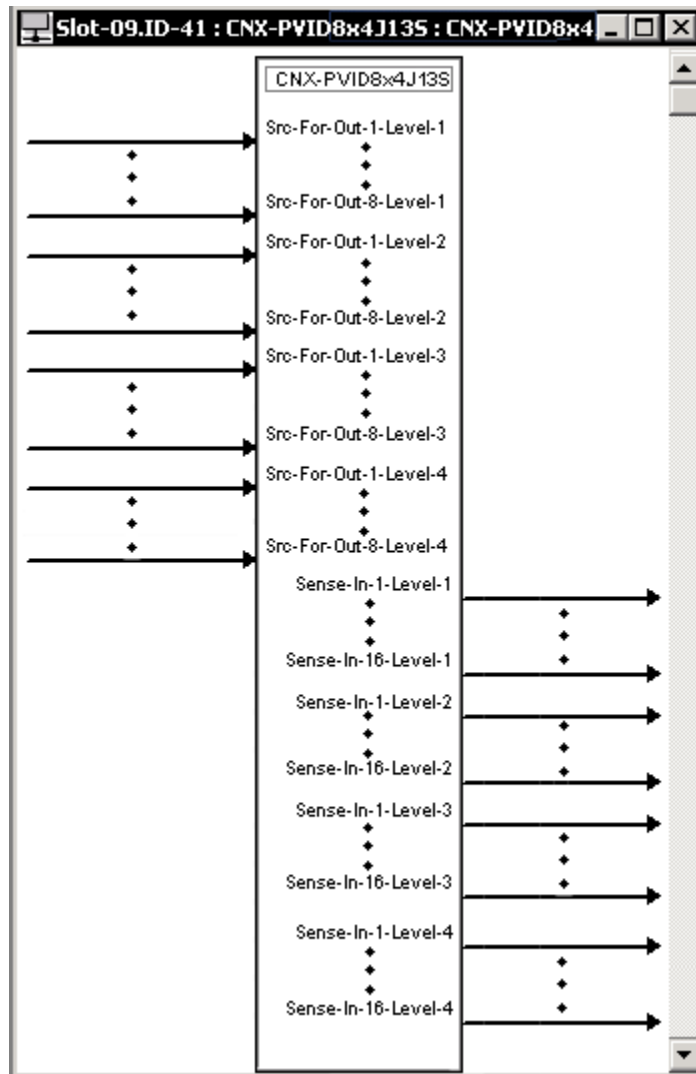
Detail View of the CNX-PVID8x4J13S Symbol**CNX-PVID8x4J13S Symbol Input Descriptions**

INPUT(S)	FUNCTION(S)
Src-For-Out-1-Level-1 through Src-For-Out-8-Level-1	Provide the analog equivalent (1 through 24) via the Analog Initialize symbol (decimal format) on this line so that the video source connected to the given input (on level 1, including the extension from level 3) can be switched to the specified output on level 1.

(continued on next page)

CNX-PVID8x4J13S Symbol Input Descriptions (continued)

INPUT(S)	FUNCTION(S)
Src-For-Out-1-Level-2 through Src-For-Out-8-Level-2	Provide the analog equivalent (1 through 16) via the Analog Initialize symbol (decimal format) on this line so that the video source connected to the given input (on level 2) can be switched to the specified output on level 2.
Src-For-Out-1-Level-3 through Src-For-Out-8-Level-3	Provide the analog equivalent (9 through 16) via the Analog Initialize symbol (decimal format) on this line so that the video source connected to the given input (on half of level 3) can be switched to the specified output on level 3.
Src-For-Out-1-Level-4 through Src-For-Out-8-Level-4	Provide the analog equivalent (1 through 16) via the Analog Initialize symbol (decimal format) on this line so that the video source connected to the given input (on level 4) can be switched to the specified output on level 4.

CNX-PVID8x4J13S Symbol Digital Output Descriptions

OUTPUT(S)	FUNCTION(S)
Sense-in-1-Level-1 through Sense-in-16-Level-1	High if a video signal is detected on the specific input (1 – 16) on level 1 (including extension from level 3); otherwise, 0 (zero).
Sense-in-1-Level-2 through Sense-in-16-Level-2	High if a video signal is detected on the specific input (1 – 16) on level 2; otherwise, 0 (zero).
Sense-in-1-Level-3 through Sense-in-16-Level-3	High if a video signal is detected on the specific input (1 – 16) on half of level 3; otherwise 0 (zero).
Sense-in-1- Level-4 through Sense-in-16-Level-4	High if a video signal is detected on the specific input (1 – 16) on level 4; otherwise, 0 (zero).

This symbol allows the programmer to attach inputs and outputs to the CNX-PVID8x4 when it is configured as four levels with varying quantities of inputs (one with 24 inputs to eight outputs, two with 16 inputs to eight outputs, and the other with eight inputs to eight outputs). On level 1, the 24 inputs can be switched to any of the eight outputs on the same level. Likewise, the 16 inputs on level 2 or 4 can be switched to any of the eight outputs on level 2 or 4, respectively, and the eight inputs on level 3 can be switched to any of the eight outputs on level 3. (Refer to the following figure.)

DEPICTION OF LEVELS ON BACK OF UNIT:

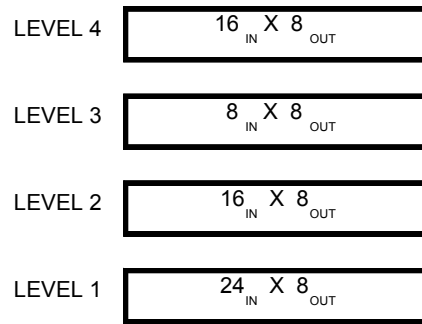

DEPICTION OF SYMBOL IN SIMPL WINDOWS:

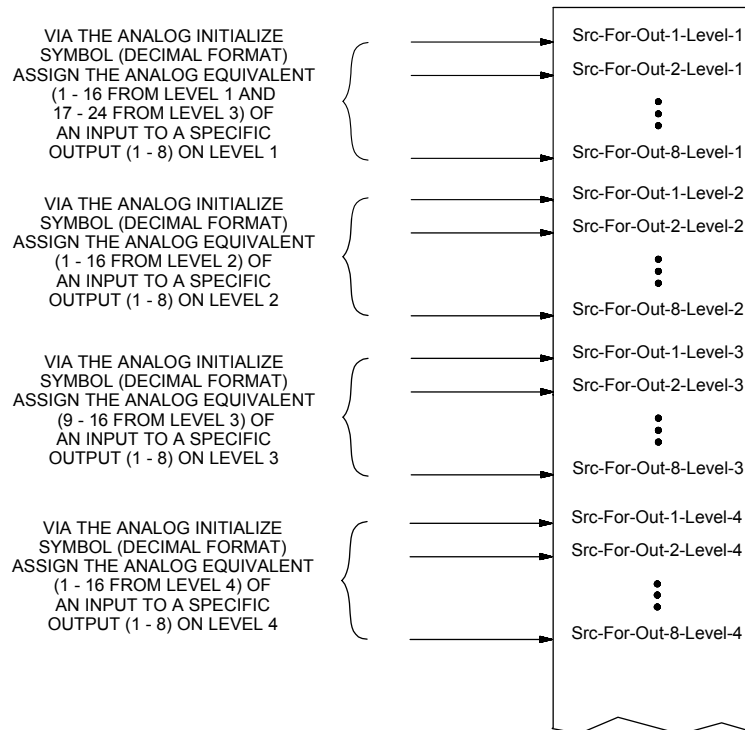

Example Program

The example program for the CNX-PVID8x4 is available from the Crestron website (www.crestron.com/exampleprograms). Search for PVID8_Video_Switcher_Test_program_on_Pro2.zip.

Uploading and Upgrading

Assuming a PC is properly connected to the entire system, Crestron programming software allows the programmer to upload programs and projects after their development to the system and network devices. However, there are times when the files for the program and projects are compiled and not uploaded. Instead, compiled files may be distributed from programmers to installers, from Crestron to dealers, etc. Even firmware upgrades are available from the Crestron website as new features are developed after product releases. In those instances, one has the option to upload via the programming software or to upload and upgrade via the Crestron Viewport.

NOTE: The Crestron Viewport is available as a pull-down command from SIMPL Windows and VT Pro-e (**Tools | Viewport**) or as a standalone utility. The Viewport utility accomplishes multiple system tasks, primarily via an RS-232 or TCP/IP connection between the control system and a PC. It is used to observe system processes, upload new operating systems and firmware, change system and network parameters, and communicate with network device consoles and touchpanels, among many other tasks. Viewport can also function as a terminal emulator for generic file transfer. All of these functions are accessed through the commands and options in the Viewport menus. Therefore, for its effectiveness as a support and diagnostic tool, the Crestron Viewport may be preferred over development tools when uploading programs and projects.

The following sections define how one would upload a SIMPL Windows program or upgrade the firmware of the CNX-PVID8X4. However, before attempting to upload or upgrade, it is necessary to establish communications.

Communication Settings

NOTE: For laptops and other PCs without a built-in RS-232 port, Crestron recommends the use of PCMCIA cards, rather than USB-to-serial adapters. If a USB-to-serial adapter must be used, Crestron recommends the following devices:

Belkin (large model) F5U103
I/O Gear GUC232A
Keyspan USA-19QW

Results may vary depending on the computer being used. Other models, even from the same manufacturer, may not yield the same results.

The procedure in this section provides details for RS-232 communication between the PC and the control system. If TCP/IP communication is preferred, consult the latest version of the Crestron e-Control Reference Guide (Doc. 6052) or the respective Operations Guide for the control system. These documents are available from the Downloads | Product Manuals section of the Crestron website (www.crestron.com). Refer to the following figure for a typical connection diagram when uploading files.

NOTE: Use a standard DB9 male to female “straight-through” cable.

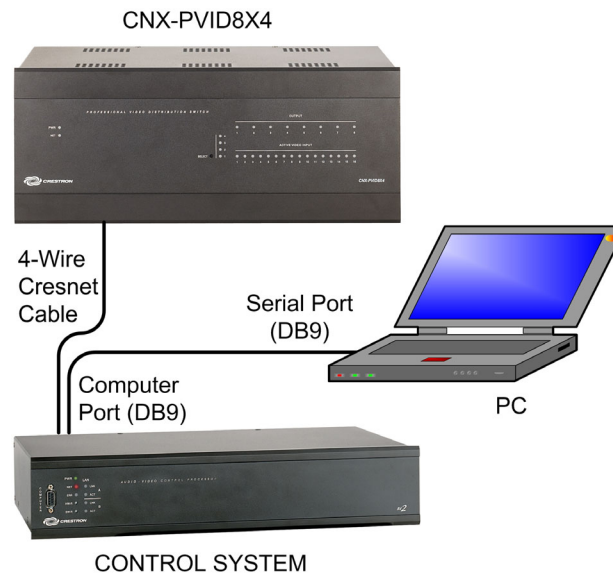
Typical Connection Diagram when Uploading

1. Open the Crestron Viewport.
Either launch the stand-alone version of Viewport, or start SIMPL Windows or VT Pro-e, and from the menu bar, select **Tools | Viewport**.
2. Refer to the figure after this step. From the Viewport menu, select **Setup | Communications settings** (alternatively, press **Alt+D**) to open the “Port Settings” window.

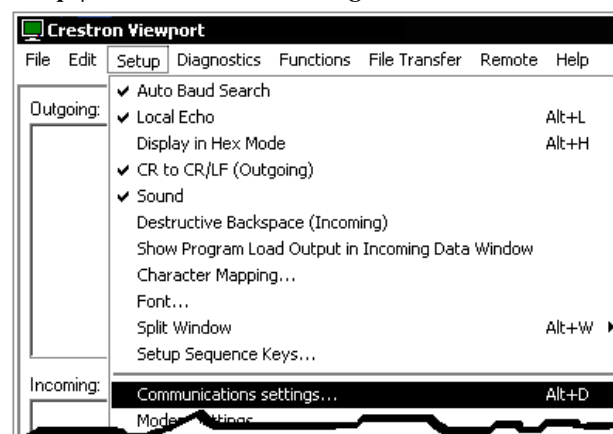
Setup | Communications Settings Command

3. Select **RS-232** as the connection type. Verify that an available COM port (COM 1 is shown following this step) is selected, and that all communication parameters and necessary options from the “Port Settings” window are selected as shown. Click the **OK** button to save the settings and close the window.

“Port Settings” Window

NOTE: The parameters shown in the illustration above are the port settings for a 2-Series control system. Consult the Operations Guide for the control system being used for exact parameter selection.

- To verify communication, select **Diagnostics | Establish Communications (Find Rack)**. This should display a window that gives the COM port and baud rate. If communication cannot be established, refer to the “Troubleshooting Communications” section in the respective Operations Guide for the control system.

Uploading a SIMPL Windows Program

The SIMPL Windows file can be uploaded to the control system using SIMPL Windows or via the Crestron Viewport.

Upload via SIMPL Windows

- Start SIMPL Windows.
- Select **File | Open** to view the “Open” window, navigate to the SIMPL Window file (.smw), and click **Open**.
- Select **Project | Transfer Program**.

Upload via Crestron Viewport

- Verify that the procedure for “Communication Settings” that begins on page 31 has been performed.
- As shown after this step, select **File Transfer | Send Program** (alternatively, press **Alt+P**) from the Viewport menu.

A control system source file has the extension .smw. A compiled SIMPL Windows file has the extension .spz for a 2-Series control system, .bin for CNX generation, and .csz for CNX generation with SIMPL+.

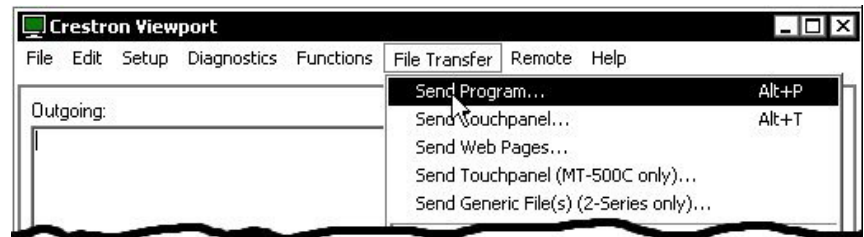
File Transfer | Send Program Command

3. The “Send Program” window appears, as shown after this step. Click **Browse**, locate the compiled file (.spz for PRO2), and click **Open**. This will display the program's header information and enable one or both of the *What to Send* check boxes. If the program does not contain any SIMPL+ modules, only the *SIMPL Program* check box will be enabled. If it does contain SIMPL+ modules, then the *SIMPL+ Program(s)* check box will also be enabled. Select one or both check boxes and then click **Send Program** to begin the transfer.

NOTE: Refer to the respective Operations Guide for the control system for details about the other fields shown on the “Send Program” window.

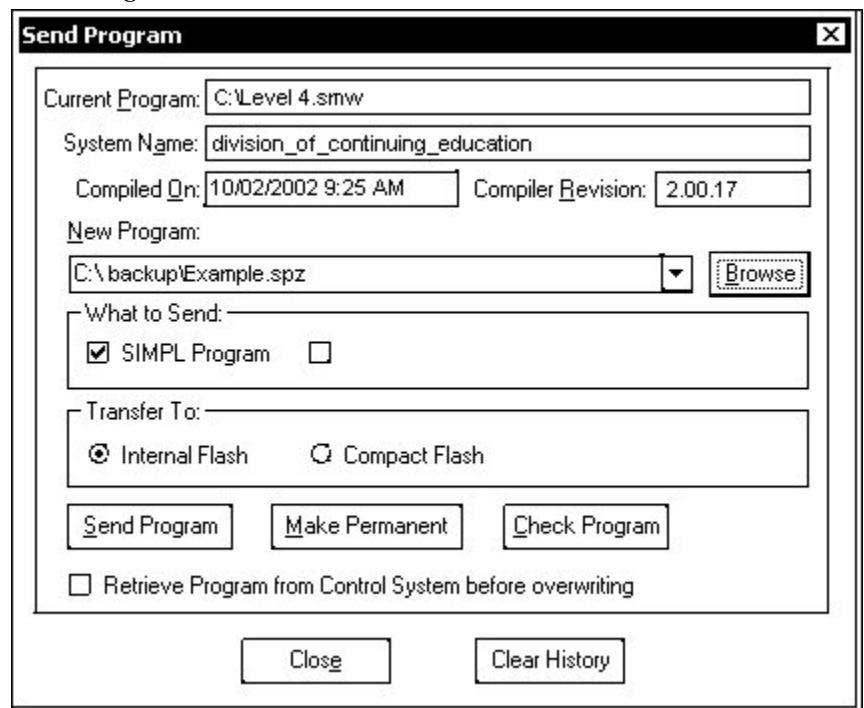
“Send Program” Window

4. To verify that the program has been transferred successfully, select **Diagnostics | Report Program Information**. This should display a window that provides details about the current program loaded into the control system.

A firmware upgrade file has the extension .upg.

Firmware Upgrade

To take advantage of all the CNX-PVID8X4 features, it is important that the unit contains the latest firmware available. Therefore, please check the Crestron website (http://www.crestron.com/downloads/software_updates.asp) for the latest version of firmware. Not every product has a firmware upgrade, but as Crestron improves functions, adds new features, and extends the capabilities of its products, firmware upgrades are posted. To upgrade the firmware, complete the following steps.

1. Make sure that “Communication Settings” that begins on page 31 has been performed.
2. As shown after this step, select **File Transfer | Update Network Device Firmware** from the Viewport menu.

File Transfer | Update Network Device Firmware Command

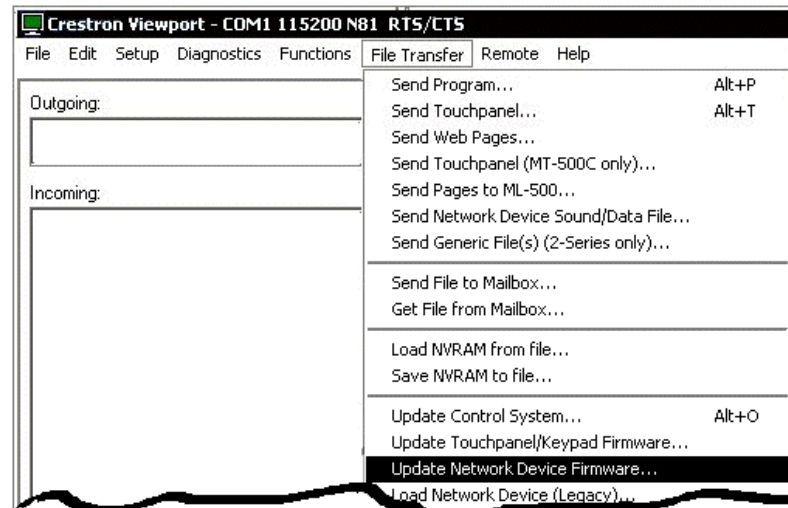

3. As shown after this step, select the Net ID of the CNX-PVID8X4 and then click **OK**. The “Open” window appears (refer to the subsequent graphic).

“Select Network ID” Window

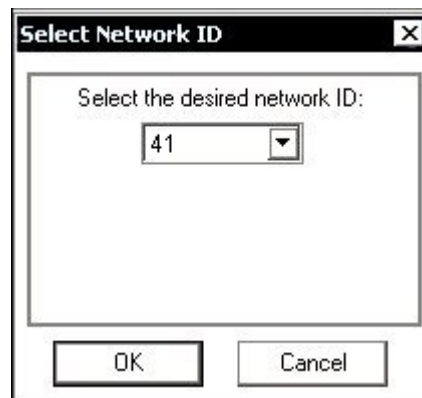

NOTE: When transferring any Cresnet file (touchpanel project/firmware), lower the port speed baud rate to 38400 to match the Cresnet bus speed.

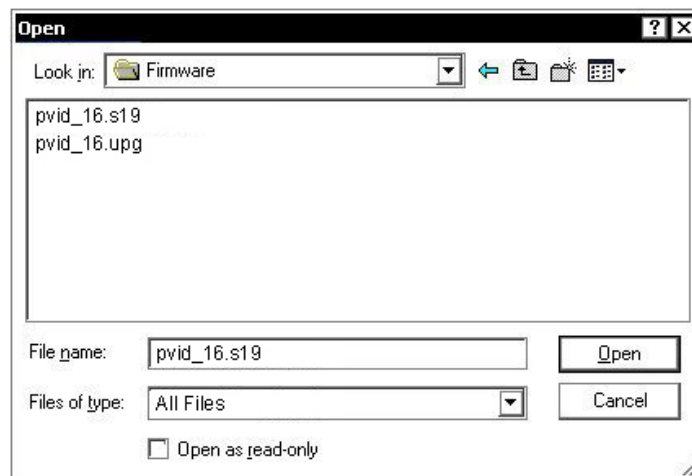
“Open” Window

4. Browse to the desired firmware file and click **Open** to begin the transfer.

Problem Solving

Troubleshooting

The following table provides corrective action for possible trouble situations. If further assistance is required, please contact a Crestron customer service representative.

CNX-PVID8x4 Troubleshooting

TROUBLE	POSSIBLE CAUSE(S)	CORRECTIVE ACTION
CNX-PVID8x4 does not function.	Incorrect power supply	Use a Crestron power supply with sufficient power for the network.
PWR LED does not illuminate.	CNX-PVID8x4 is not receiving power.	Verify that cables plugged into NET ports are secure.
NET LED does not illuminate.	Improper Net ID.	Verify that CNX-PVID8x4 Net ID matches Net ID in the software program. Refer to "Identity Code" in this Operations Guide.
	Loose network connection.	Verify that cable plugged into NET port is secure.
OUTPUT LEDs do not illuminate.	Loose connection.	Verify that (RCA or RJ45) cables connected to OUTPUT ports are secure.
ACTIVE VIDEO INPUT LEDs do not illuminate.	Input without sync.	Confirm that input contains sync (only inputs with sync can be reliably detected).
Blurry video.	Terminator missing from INPUT connector.	Terminators should remain attached unless the INPUT connectors of multiple units are connected (loop-through). The last unit in the loop must have the terminators installed.

Further Inquiries

If you cannot locate specific information or have questions after reviewing this guide, please take advantage of Crestron's award winning customer service team by calling the Crestron corporate headquarters at 1-888-CRESTRON [1-888-273-7876]. For assistance in your local time zone, refer to the Crestron website (www.crestron.com) for a listing of Crestron worldwide offices.

You can also log onto the online help section of the Crestron website (www.crestron.com) to ask questions about Crestron products. First-time users will need to establish a user account to fully benefit from all available features.

Future Updates

As Crestron improves functions, adds new features, and extends the capabilities of the CNX-PVID8x4, additional information and programming examples may be made available as manual updates. These updates are solely electronic and serve as intermediary supplements prior to the release of a complete technical documentation revision.

Check the Crestron website (www.crestron.com) periodically for manual update availability and its relevance. Updates are available from the Downloads | Product Manuals section and are identified as an “Addendum” in the Download column.

Return and Warranty Policies

Merchandise Returns / Repair Service

1. No merchandise may be returned for credit, exchange, or service without prior authorization from CRESTRON. To obtain warranty service for CRESTRON products, contact the factory and request an RMA (Return Merchandise Authorization) number. Enclose a note specifying the nature of the problem, name and phone number of contact person, RMA number, and return address.
2. Products may be returned for credit, exchange, or service with a CRESTRON Return Merchandise Authorization (RMA) number. Authorized returns must be shipped freight prepaid to CRESTRON, 6 Volvo Drive, Rockleigh, N.J., or its authorized subsidiaries, with RMA number clearly marked on the outside of all cartons. Shipments arriving freight collect or without an RMA number shall be subject to refusal. CRESTRON reserves the right in its sole and absolute discretion to charge a 15% restocking fee, plus shipping costs, on any products returned with an RMA.
3. Return freight charges following repair of items under warranty shall be paid by CRESTRON, shipping by standard ground carrier. In the event repairs are found to be non-warranty, return freight costs shall be paid by the purchaser.

CRESTRON Limited Warranty

CRESTRON ELECTRONICS, Inc. warrants its products to be free from manufacturing defects in materials and workmanship under normal use for a period of three (3) years from the date of purchase from CRESTRON, with the following exceptions: disk drives and any other moving or rotating mechanical parts, pan/tilt heads and power supplies are covered for a period of one (1) year; touchscreen display and overlay components are covered for 90 days; batteries and incandescent lamps are not covered.

This warranty extends to products purchased directly from CRESTRON or an authorized CRESTRON dealer. Purchasers should inquire of the dealer regarding the nature and extent of the dealer's warranty, if any.

CRESTRON shall not be liable to honor the terms of this warranty if the product has been used in any application other than that for which it was intended, or if it has been subjected to misuse, accidental damage, modification, or improper installation procedures. Furthermore, this warranty does not cover any product that has had the serial number altered, defaced, or removed.

This warranty shall be the sole and exclusive remedy to the original purchaser. In no event shall CRESTRON be liable for incidental or consequential damages of any kind (property or economic damages inclusive) arising from the sale or use of this equipment. CRESTRON is not liable for any claim made by a third party or made by the purchaser for a third party.

CRESTRON shall, at its option, repair or replace any product found defective, without charge for parts or labor. Repaired or replaced equipment and parts supplied under this warranty shall be covered only by the unexpired portion of the warranty.

Except as expressly set forth in this warranty, CRESTRON makes no other warranties, expressed or implied, nor authorizes any other party to offer any warranty, including any implied warranties of merchantability or fitness for a particular purpose. Any implied warranties that may be imposed by law are limited to the terms of this limited warranty. This warranty statement supercedes all previous warranties.

Trademark Information

All brand names, product names, and trademarks are the sole property of their respective owners. Windows is a registered trademark of Microsoft Corporation. Windows95/98/Me/XP and WindowsNT/2000 are trademarks of Microsoft Corporation.

This page intentionally left blank.



Crestron Electronics, Inc.
15 Volvo Drive Rockleigh, NJ 07647
Tel: 888.CRESTRON
Fax: 201.767.7576
www.crestron.com

Operations Guide – DOC. 8166A
04.04

Specifications subject to
change without notice.